

D

D40
Reference manual
1.5 en

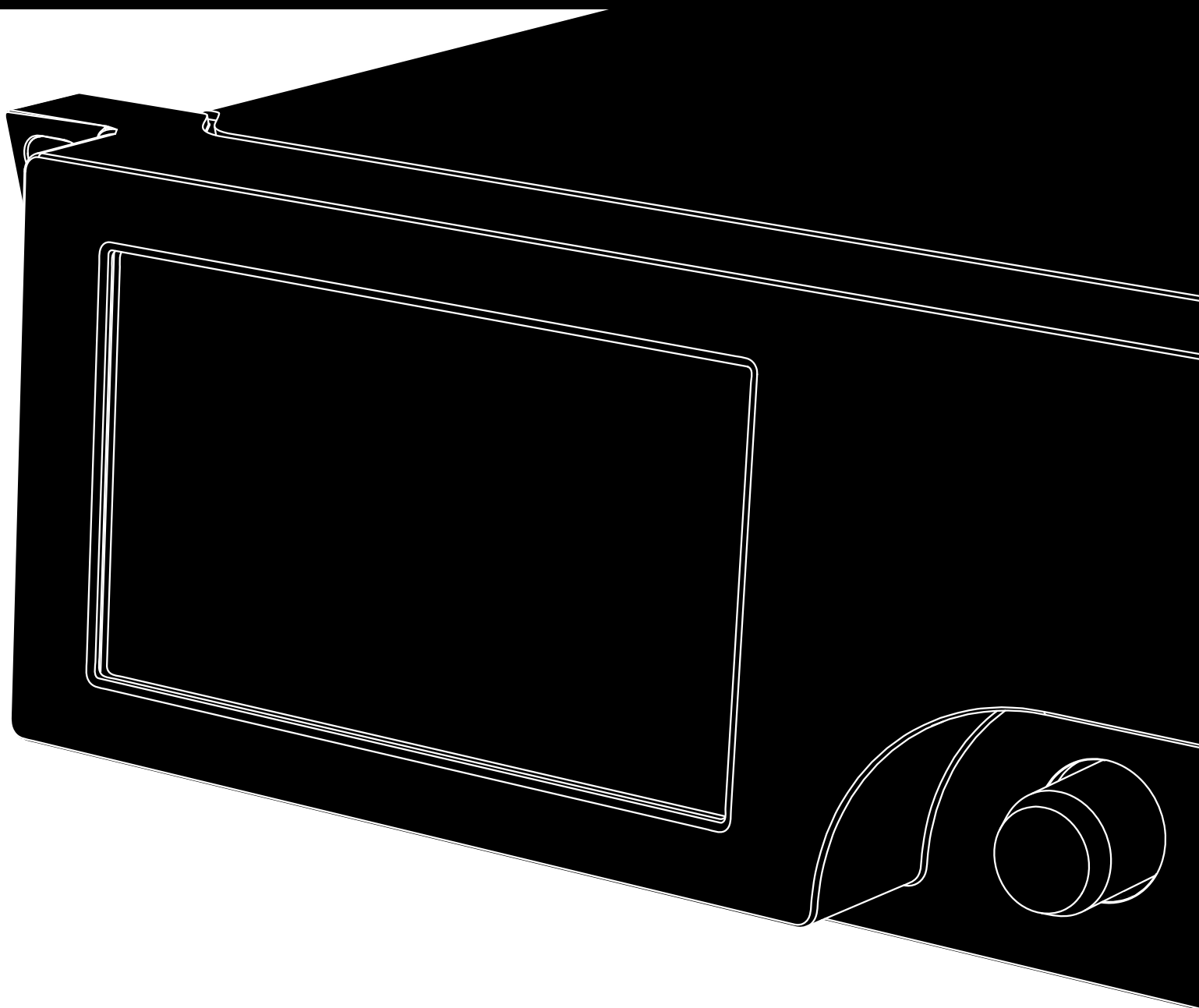

Notes on document version

All previous versions of this document are hereby no longer valid.

Version 1.5:

Technical specifications: A/D conversion details added.

Refer to:

⇒ "Digital Signal Processing" on page 7.

General information

D40 Reference manual

Version: 1.5 en, 08/2023, D2038.EN .01

Copyright © 2023 by d&b audiotechnik GmbH & Co. KG; all rights reserved.

Keep this document with the product or in a safe place so that it is available for future reference.

We recommend you to regularly check the d&b website for the latest version of this document.

When reselling this product, hand over this document to the new owner.

If you supply d&b products, please draw the attention of your customers to this document. Enclose the relevant documents with the systems. If you require additional documents for this purpose, you can order them from d&b.

d&b audiotechnik GmbH & Co. KG
Eugen-Adolff-Str. 134, D-71522 Backnang, Germany
T +49-7191-9669-0, F +49-7191-95 00 00
docadmin@dbaudio.com, www.dbaudio.com

Explanation of graphical symbols



The lightning symbol within a triangle is intended to alert the user to the presence of uninsulated "dangerous voltages" within the unit's chassis that may be of sufficient magnitude to constitute a risk of electric shock to humans.



The exclamation point within a triangle is intended to alert the user to the presence of important operating and service instructions in the literature accompanying the product.

Before using this product, carefully read the applicable items of the following safety instructions.

1. Keep these instructions for future reference.
2. Read these instructions.
3. Heed all warnings.
4. Follow all instructions.
5. **WARNING!** To reduce the risk of fire or electric shock:
 - Do not expose this unit to rain or moisture.
 - Keep water or other liquids away from the unit.
 - Do not place liquid filled containers, for example beverages, on top of the unit.
 - Do not operate the unit while it is wet or standing in liquid.
6. Always operate the unit with the chassis ground wire connected to the electrical safety earth.
Do not defeat the safety purpose of a grounding-type plug. A grounding-type plug has two blades and a third grounding prong. The third prong is provided for your safety. If the provided plug does not fit into your outlet, consult an electrician for replacement of the obsolete outlet.
7. Do not use this unit if the power cord is damaged or frayed. Protect the power cord from being walked upon or pinched, particularly at the plugs and the point where it exits from the apparatus.
8. The unit is intended for use in a 19" rack. Follow the mounting instructions. When a rack on wheels is used, exercise caution when moving the loaded rack to avoid injury from tipping over.
9. Unplug this apparatus during lightning storms or when unused for long periods of time.
10. Never connect an output pin to any other amplifier input or output pin or to the earth (ground). This may damage the unit or lead to electric shock.
11. Lay all cables connected to the unit carefully so that they cannot be crushed by vehicles or other equipment and that no one can either step on them or trip over them.
12. Refer all servicing to qualified service personnel. Servicing is required when the apparatus has been damaged in any way such as:
 - Power-supply cord or plug is damaged.
 - Liquid has been spilled into the unit.
 - An object has fallen into the unit.
 - The unit has been exposed to rain or moisture.
 - The unit does not operate normally.
 - The unit was dropped or the chassis is damaged.
 - Do not remove top or bottom covers. Removal of the covers will expose hazardous voltages. There are no user serviceable parts inside and removal may void the warranty.
13. Use the mains plug as the disconnecting device and keep it readily accessible. If the mains plug is not readily accessible due to mounting in a 19" equipment cabinet, then the mains plug for the entire rack must be readily accessible.
14. An experienced user must always supervise the equipment, especially if inexperienced adults or minors are using the equipment.

1	Intended use	5	7.8	Speaker.....	50
1.1	Loudspeaker types.....	5	7.8.1	ArrayProcessing.....	52
2	Scope of supply	6	7.8.2	LoadMatch.....	53
3	Technical specifications	7	7.8.3	LINEAR setup.....	54
3.1	Current/power draw and thermal dissipation.....	10	7.9	Channel linking.....	54
4	Overview	13	7.10	Frequency generator.....	55
4.1	Connections.....	13	8	Web Remote interface	56
4.2	Controls and indicators - User interface.....	13	9	Operation (Hardware references)	61
5	Startup	14	9.1	Power supply.....	61
5.1	Rack mounting and cooling.....	14	9.1.1	Active Power Factor Correction (PFC).....	61
5.2	Connections.....	15	9.1.2	Mains voltage monitoring.....	61
5.2.1	Mains connection.....	15	9.1.3	Automatic mains range selection.....	61
5.2.2	Audio input and output connectors.....	16	9.1.4	Mains inrush current limiter.....	62
5.2.3	SPEAKER OUTPUTS.....	17	9.1.5	Mains supply requirements.....	62
5.2.4	Network connections (PRI/SEC).....	18	9.1.6	Generator operation/UPS requirements.....	63
5.3	Controls and indicators.....	19	9.2	Power amplifiers.....	64
5.3.1	Mains power switch.....	19	9.3	Cooling fans.....	64
5.3.2	TFT color touchscreen - User interface.....	19	10	Service/Maintenance and care	65
5.3.2.1	Operating concept.....	20	10.1	Service.....	65
5.3.2.2	Standby mode.....	22	10.2	Maintenance and care.....	65
5.3.2.3	Mute functions.....	23	10.2.1	Touchscreen cleaning.....	65
6	Device setup	24	10.2.2	Touchscreen calibration.....	66
6.1	Device name.....	25	10.3	Possible error messages.....	67
6.2	Input.....	25	11	Manufacturer's declarations	70
6.2.1	Input management.....	26	11.1	Declaration of Conformity.....	70
6.2.1.1	Input monitoring.....	26	11.2	WEEE Declaration (Disposal).....	70
6.2.1.2	Input gain.....	27	11.3	Licenses and Copyright.....	70
6.2.1.3	Fallback.....	28			
6.2.1.4	Override.....	29			
6.3	Output.....	30			
6.4	Network.....	30			
6.4.1	IP settings.....	31			
6.4.2	Remote ID.....	32			
6.5	More.....	32			
6.5.1	Preferences.....	32			
6.5.1.1	Display.....	33			
6.5.1.2	Lock.....	33			
6.5.1.3	Preferences/More.....	35			
6.5.1.3.1	System reset.....	35			
6.5.2	Info.....	36			
6.5.3	Levels.....	36			
6.5.4	Mains current limiter (MCL).....	37			
6.5.5	Energy saving.....	38			
6.5.6	AmpPresets.....	39			
6.5.7	Event log.....	40			
7	Channel setup	41			
7.1	Channel name.....	42			
7.2	Configuration switches - Filter_1, _2, _3.....	43			
7.3	Level.....	43			
7.4	EQ - Equalizer	43			
7.5	DLY - Delay.....	46			
7.6	Input routing.....	47			
7.7	System check/LM.....	48			
7.7.1	System check.....	48			
7.7.2	Load monitoring (LM).....	49			

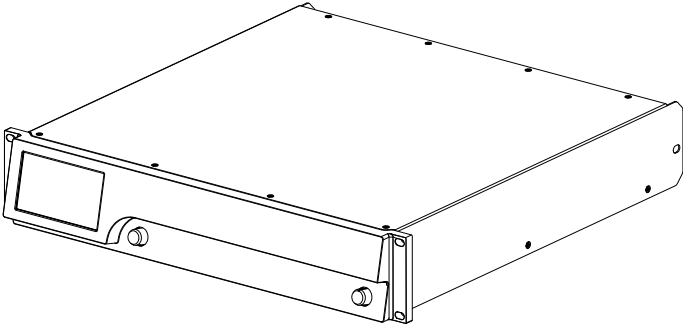

The d&b D40 amplifier is designed for mobile applications and is intended to be used with applicable d&b loudspeakers.

A "LINEAR" setup is available allowing the amplifier to be used as a linear power amplifier.

Note: d&b audiotechnik will accept no liability for any damages to third-party loudspeakers when operated with d&b amplifiers in "LINEAR" mode.

NOTICE!

The device complies with the electromagnetic compatibility requirements of EN 55032:2019 (product family standard for audio, video, audio-visual and entertainment lighting control apparatus for professional use) for the environment Class B (residential).

Acoustic interference and malfunctions may occur if the unit is operated in the immediate vicinity of high-frequency transmitters (e.g. wireless microphones, mobile phones, etc.). Damage to the device is unlikely, but cannot be excluded.

1.1 Loudspeaker types

The maximum number of cabinets driven by each channel varies depending on their nominal impedance. It can be found in the respective loudspeaker manual and also in the data section of each loudspeaker product page on the d&b website at www.dbaudio.com.

The minimum recommended impedance per channel is 4 ohms.

Nom. impedance	Cabinets per channel
4 Ω	1
8 Ω	2
12 Ω	3
16 Ω	4
20 Ω	5

A list of d&b loudspeakers supported by the amplifier is included in the Release notes of the amplifier firmware. The latest version can be found on the d&b website at www.dbaudio.com.

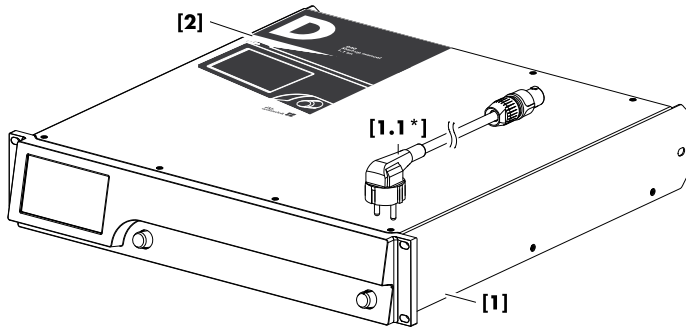

Before starting up the device, please verify the shipment for completeness and proper condition of the items.

If there is any sign of obvious damage to the unit and/or the power cord, do not operate the unit and contact your local dealer from whom you received it.

Pos.	Qty.	d&b Code	Description
[1]	1	Z2850	d&b D40 Amplifier
Including:			
[1.1*]	1	Z2612.xxx	Power cord (specific to country*)
[2]	1	D2037.EN .01	d&b D40 Start-up manual.

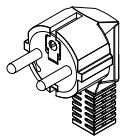

Z2612.000
3-pin Schuko
CEE 7/7

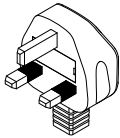

Z2612.010
3-pin UK
BS 1363A

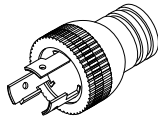

Z2612.025
3-pin U.S.
NEMA L6-20P

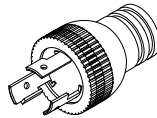

Z2612.035
3-pin Japan
NEMA L6-20P

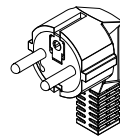

Z2612.040
3-pin South Korea
KS C8305



Z2612.050
3-pin Australia
AS 3112

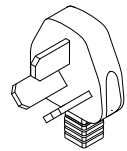

Z2612.060
3-pin China
GB 2099

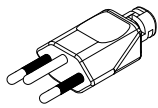

Z2612.070
3-pin Switzerland
SEV 1011

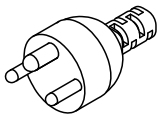

Z2612.090
3-pin Denmark
Afsnit 107-2-D1

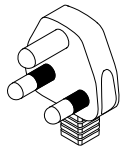

Z2612.100
3-pin South Africa
SANS 164-1

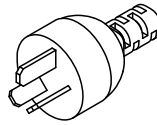

Z2612.110
3-pin Argentina
IRAM 2073

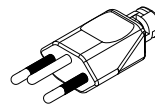

Z2612.120
3-pin Brazil
NBR 14136

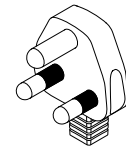

Z2612.130
3-pin India
IS 1293

***Mains plug types and associated standards**
(Similar illustrations, not in scale)

Operating conditions

Operating temperature (*continuous/**short-term)
.....	-10 °C ... +40*/+50** °C (+14 °F ... +104*/+122** °F)
Storage temperature -20 °C ... +70 °C (-4 °F ... +158 °F)
Humidity (rel.), non-condensating < 70 %

Power supply

Switched mode power supply with automatic mains range selection and active Power Factor Correction (PFC).

Mains connector powerCON® TRUE 1 TOP
Rated mains voltage (High range) 208 - 240 V, 50 - 60 Hz
Rated mains current (High range) 13 A
Rated mains voltage (Low range) 100 - 127 V, 50 - 60 Hz
Rated mains current (Low range) 20 A

Protection circuits

Mains and power supply: Overvoltage and undervoltage, inrush current limiter, internal fuse.

Output: Overcurrent, DC offset, HF voltage limiter, pop-noise suppression.

Cooling: Temperature-dependent fan, self-resetting overtemperature protection.

Power consumption (typical values)

Standby 13 W
Idling 130 W
Peak output 2900 W

Audio power outputs*

SPEAKER OUTPUTS A/B/C/D 4 x NL4
4 CHANNEL OUTPUT 1 x NL8
Maximum output voltage/current 180 V _{peak} /35 A _{peak}
Output power rating EIA-426B noise CF 12 dB 4 x 2000 W/8 Ω
..... 4 x 2400 W/4 Ω
Sine wave 1 kHz, long term, +40 °C (+104 °F) 4 x 250 W/4 Ω
Frequency response (-1 dB, Linear mode) 35 Hz - 25 kHz
Gain (Linear mode @ 0 dB) 31 dB

Output noise/Dynamic range

Output noise (BW 20 kHz)/dynamic range (BW 20 kHz, reference 180 V _{pk})
Analog input 350 μV _{RMS} /111 dB
Analog input, A-weighting 250 μV _{RMS} /114 dB
Digital input 200 μV _{RMS} /116 dB
Digital input, A-weighting 150 μV _{RMS} /119 dB

THD+N / Crosstalk

THD+N (unweighted, 20 - 20 kHz)
4 x 250 W/8 ohms < -86 dB/0.005 %
4 x 250 W/4 ohms < -83 dB/0.007 %
Crosstalk (20 - 20 kHz) < -70 dB
..... 4 x 250 W into 8/4 Ω

Analog inputs and outputs

INPUT A1 - A4 3 pin XLR female
Pin assignment 1 = GND, 2 = pos., 3 = neg.
Input impedance 32 kΩ, electronically balanced
CMRR @ 100 Hz/1 kHz / 10 kHz >80/>80/>70 dB
Maximum input level (balanced/unbalanced) +25/+18 dBu
..... +27.3 dBu @ 0 dBFS
LINK A1 - A4, parallel to input 3 pin XLR male
Pin assignment 1 = GND, 2 = pos., 3 = neg.

Digital inputs and outputs

IN - D1/2, D3/4 3 pin XLR female, AES3
Pin assignment 1 = GND, 2 = AES Signal, 3 = AES Signal
Input impedance 110 Ω, transformer balanced
Sampling frequency 44.1 48 96 192 kHz
Word length 16 - 24 bit
OUT - D1/2, D3/4 3 pin XLR male
..... electronically balanced
Output modes Mains on: analog signal buffering (refresh)
..... Mains off/power fail: bypass relay

Network (PRI/SEC)

Connector type 2 x RJ 45 (etherCON®)
PRI Remote control via R1, Star topology
SEC Currently disabled

IP settings (factory default)

IP address/Subnet mask 192.168.1.40/255.255.255.0
------------------------	----------------------------------

Digital Signal Processing

System start-up time < 21 sec.
Time to tone (Standby/ReadyStandby) < 4/ < 1 sec.
Time to tone (Off/Wake on Audio) < 21 / < 4 sec.
Conversion 96 kHz
Latency analog/digital (AES) input 0.3/0.3 msec.
A/D conversion 27 Bit (dual-stacked A/D converters)
Internal processing Combination of high-resolution fixed point
..... and floating point processing
Equalizer two user definable 16-band equalizers
..... Filter types: PEQ/Notch/HiShlv/LoShlv/Asym
Delay 0.3 msec. - 10 sec.
Frequency generator Pink noise or Sine wave 10 Hz - 20 kHz

Controls and indicators

POWER Mains power switch
SCROLL/EDIT Digital rotary encoder
TFT color touchscreen 4.3"/480 x 272 pixels

Fan noise emission

Rack mounted, measured on axis, 1 m (3.3 ft) to front panel, A-weighting.
 Min./Max. RPM 30/50 dB(A)
 Ambient temperature 23 °C/73.4 °F

Dimensions and weight

Height x width x depth 2 RU x 19" x 465 mm (18.3")
 Weight 13.8 kg/30.4 lb

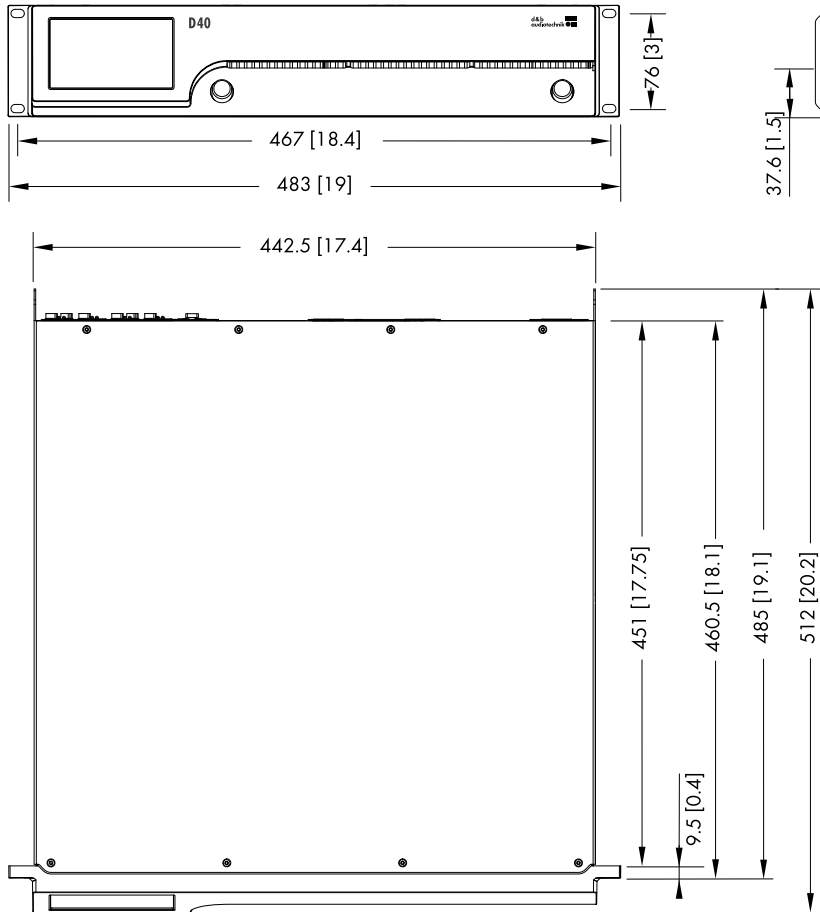

D40 enclosure dimensions in mm [inch]

*** Audio power output – Measurement references:**

All data is valid for 23 °C (73.4 °F) ambient temperature and 230 VAC/50 Hz mains supply.

The power rating of noise signals is defined as the maximum of the instantaneous output power divided by a factor of two.

The power of burst signals refers to the power during the "on" period.

The duration of the peak output of a sine wave signal is defined at a drop of 0.5 dB/10% relative to the maximum output power.

EIA-426B noise			
Crest factor	Load	Power rating	Power average
12 dB	4 ohms 8 ohms	4 x 2400 W 4 x 2000 W	4 x 300 W 4 x 250 W
9 dB	4 ohms 8 ohms	4 x 1300 W 4 x 2000 W	4 x 325 W 4 x 500 W
6 dB	4 ohms 8 ohms	4 x 700 W 4 x 1150 W	4 x 375 W 4 x 575 W
1 kHz burst			
On/off time	Load	Power	
20 ms/0 dB 480 ms/-20 dB	4 ohms 8 ohms	4 x 1200 W 4 x 1150 W	
200 ms/0 dB 600 ms/-20 dB	4 ohms 8 ohms	4 x 700 W 4 x 750 W	
1 kHz sine wave			
Channels used	Load	Max. output power	Duration of max. output
1	4 ohms 8 ohms	1 x 2400 W 1 x 2000 W	110 ms 2000 ms
4	4 ohms 8 ohms	4 x 2400 W 4 x 2000 W	5 ms 4 ms

3.1 Current/power draw and thermal dissipation

Measurement references

For all noise signals, the values are measured at the maximum level just before any amplifier limiter activity (no Gain Reduction).

Noise CF 12 dB: Noise signal according to EIA-426-B with a crest factor of 12 dB.

This represents the use case of live music or less compressed recorded music.

Noise CF 9 dB: Noise signal according to EIA-426-B with a crest factor of 9 dB.

This represents the use case of music with medium compression.

Noise CF 6 dB: Noise signal according to EIA-426-B with a crest factor of 6 dB.

This represents the use case of heavily compressed music.

Sine wave (100 ms): 1 kHz sine wave signal, 0 dBFS input level and a duration of 1 s.

The RMS current value is calculated over a 100 ms time window. This window is stepped in increments of 10 ms over the recording. The resulting value is the highest current within a window of 100 ms.

230 VAC / 50 Hz / 0.5 Ω Source impedance - all channels driven								
State	Load [ohms]	Mains current [A RMS]	Power factor	Input power [W]	Output power [W]	Power loss [W]	BTU/hr	kCal/hr
Off	-	0.24	0.03	1.5	-	1.5	5	1
Standby	-	0.26	0.22	13.5	-	13.5	46	12
Standby/Wake on Audio	-	0.29	0.31	20.8	-	20.8	71	18
ReadyStandby	-	0.43	0.54	52.6	-	52.6	179	45
Eco	-	0.83	0.54	103	-	103	351	89
Idling	-	0.75	0.74	127	-	127	433	109
Noise CF 12 dB	8	6.1	0.95	1300	1000	300	1024	258
	4	7.8	0.96	1700	1200	500	1706	430
Noise CF 9 dB	8	11.6	0.98	2550	2000	550	1876	473
	4	8.2	0.97	1800	1300	500	1706	430
Noise CF 6 dB	8	13	0.99	2900	2300	600	2047	516
	4	8.8	0.98	1950	1400	550	1876	473
Sine wave max. 1 s	8	16.6	-	-	-	-	-	-
	4	16.5	-	-	-	-	-	-

208 VAC / 60 Hz / 0.5 Ω Source impedance - all channels driven								
State	Load [ohms]	Mains current [A RMS]	Power factor	Input power [W]	Output power [W]	Power loss [W]	BTU/hr	kCal/hr
Off	-	0.26	0.02	1.3	-	1.3	4	1
Standby	-	0.28	0.20	11.9	-	11.9	41	10
Standby/Wake on Audio	-	0.32	0.32	20.8	-	20.8	71	18
ReadyStandby	-	0.46	0.53	50.2	-	50.2	171	43
Eco	-	0.86	0.54	97	-	97	331	83
Idling	-	0.82	0.74	126	-	126	430	108
Noise CF 12 dB	8 4	6.8 8.8	0.96 0.96	1350 1750	1000 1200	350 550	1194 1876	301 473
Noise CF 9 dB	8 4	13.1 9.2	0.98 0.98	2600 1850	2000 1300	600 550	2047 1876	516 473
Noise CF 6 dB	8 4	13.7 9.9	0.99 0.98	2750 2000	2100 1400	650 600	2218 2047	559 516
Sine wave max. 1 s	8 4	18.4 18.4	- -	- -	- -	- -	- -	- -

120 VAC / 60 Hz / 0.2 Ω Source impedance - all channels driven								
State	Load [ohms]	Mains current [A RMS]	Power factor	Input power [W]	Output power [W]	Power loss [W]	BTU/hr	kCal/hr
Off	-	0.15	0.02	0.4	-	0.4	1	0.5
Standby	-	0.23	0.41	11.4	-	11.4	39	10
Standby/Wake on Audio	-	0.32	0.50	18.8	-	18.8	64	16
ReadyStandby	-	0.60	0.72	52.0	-	52.0	177	45
Eco	-	1.44	0.60	104	-	104	355	89
Idling	-	1.26	0.86	130	-	130	444	112
Noise CF 12 dB	8 4	12.1 15.9	0.96 0.96	1350 1800	1000 1200	350 600	1194 2047	301 516
Noise CF 9 dB	8 4	18.8 16.6	0.98 0.98	2100 1900	1600 1300	500 600	1706 2047	430 516
Noise CF 6 dB	8 4	19.7 17.7	0.99 0.98	2250 2000	1650 1400	600 600	2047 2047	516 516
Sine wave max. 1 s	8 4	25.2 27.7	- -	- -	- -	- -	- -	- -

100 VAC / 60 Hz / 0.2 Ω Source impedance - all channels driven								
State	Load [ohms]	Mains current [A RMS]	Power factor	Input power [W]	Output power [W]	Power loss [W]	BTU/hr	kCal/hr
Off	-	0.13	0.02	0.3	-	0.3	1	0.5
Standby	-	0.21	0.49	10.3	-	10.3	35	9
Standby/Wake on Audio	-	0.34	0.55	18.7	-	18.7	64	16
ReadyStandby	-	0.65	0.75	48.2	-	48.2	164	41
Eco	-	1.54	0.61	94.8	-	94.8	323	82
Idling	-	1.45	0.88	128	-	128	437	110
Noise CF 12 dB	8	14.9	0.97	1400	1000	400	1365	344
	4	19.9	0.96	1850	1200	650	2218	559
Noise CF 9 dB	8	21.2	0.98	2000	1450	550	1876	473
	4	20.8	0.98	1950	1300	650	2218	559
Noise CF 6 dB	8	21.0	0.99	2000	1450	550	1876	473
	4	21.1	0.99	2000	1350	650	2218	559
Sine wave max. 1 s	8	30.3	-	-	-	-	-	-
	4	32.7	-	-	-	-	-	-

4.1 Connections

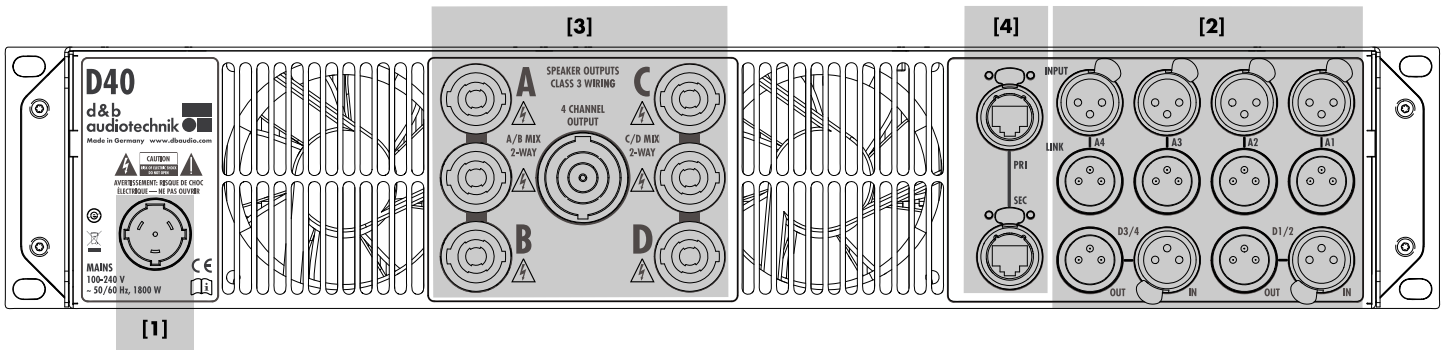

- [1]** Mains connector socket.
Refer to ⇒ Chapter 5.2.1 "Mains connection" on page 15.
- [3]** Output connector panel.
Refer to ⇒ Chapter 5.2.3 "SPEAKER OUTPUTS" on page 17.
- [2]** Audio INPUT (analog/digital) and LINK connectors.
Refer to ⇒ Chapter 5.2.2 "Audio input and output connectors" on page 16.
- [4]** Network (PRI/SEC).
Refer to ⇒ Chapter 5.2.4 "Network connections (PRI/SEC)" on page 18.

4.2 Controls and indicators - User interface

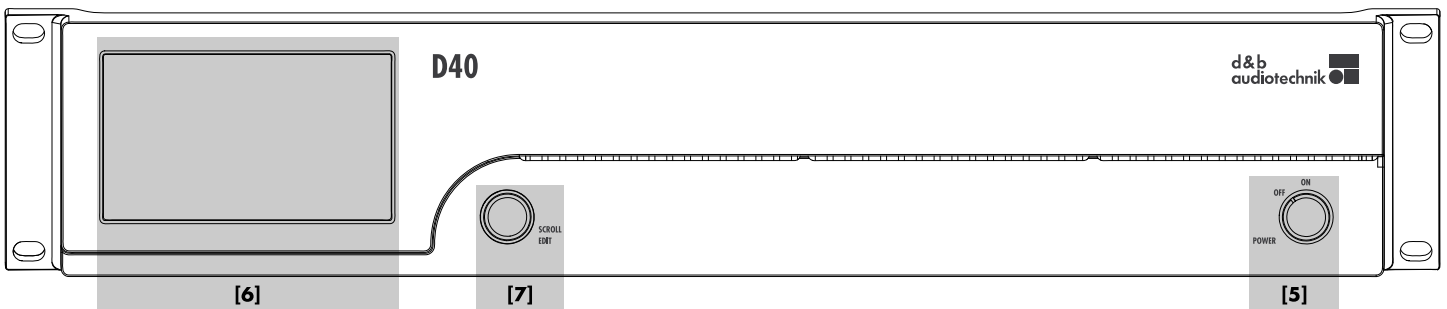

- [6]** TFT color touchscreen
4.3" / 480 x 272 pixels.

[7] Rotary encoder SCROLL/EDIT.
Refer to ⇒ Chapter 5.3 "Controls and indicators" on page 19 and .
- [5]** Mains power switch.
Refer to ⇒ Chapter 5.3 "Controls and indicators" on page 19, following ⇒ Chapter 5.3.1 "Mains power switch" on page 19.

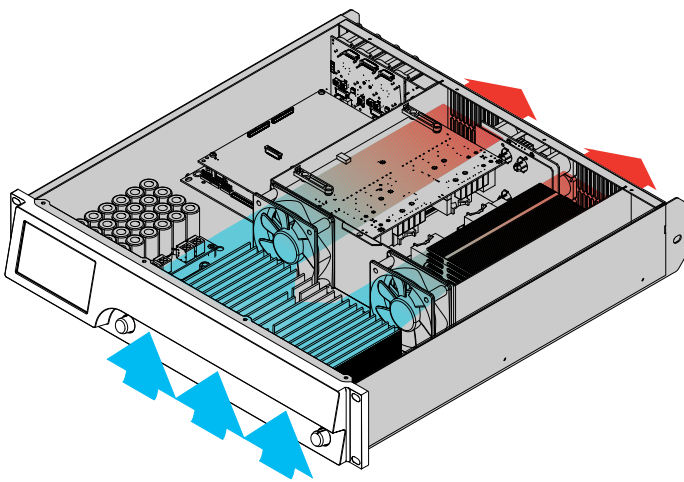
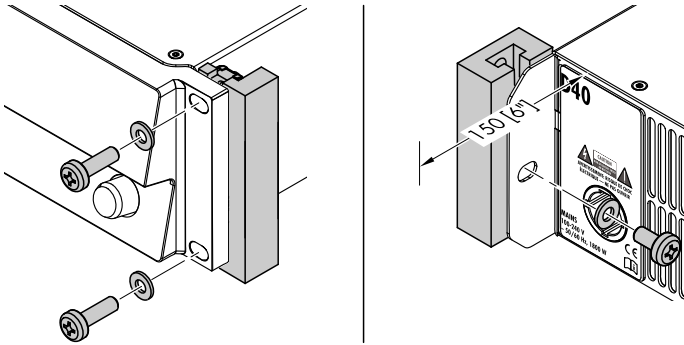

5.1 Rack mounting and cooling

Rack mounting

The enclosure is designed to fit standard 19" equipment racks or cabinets.

NOTICE!

When mounting the device into 19" equipment racks or cabinets, it is strongly recommended that you:

- **Always** fix the device at its **front AND rear-mounted rack ears** using appropriate rack mounting screws and U washers, as shown in the graphic opposite.
 - Alternatively use shelves fixed to the inner sides of the equipment rack or cabinet.
-

Cooling

Thermal conditions are a vital factor to ensure operational safety of the power amplifiers. The amplifiers are equipped with two internal fans that draw cool air from the front into the housing and channel the warm air towards the back of the device.

- Please ensure that adequate cool airflow is provided.
- Do not block or cover the front panel air intake or the vents on the rear panel.
- If the amplifiers are installed in sealed cabinets (e.g. in fixed installations), use additional fan modules with filters that can be easily replaced without opening the sealed cabinets.
- Do not combine the amplifiers with D6 or D12 amplifiers in one rack.
- Do not rack up the amplifiers together with other devices producing additional heat with opposing airflow.

5.2 Connections

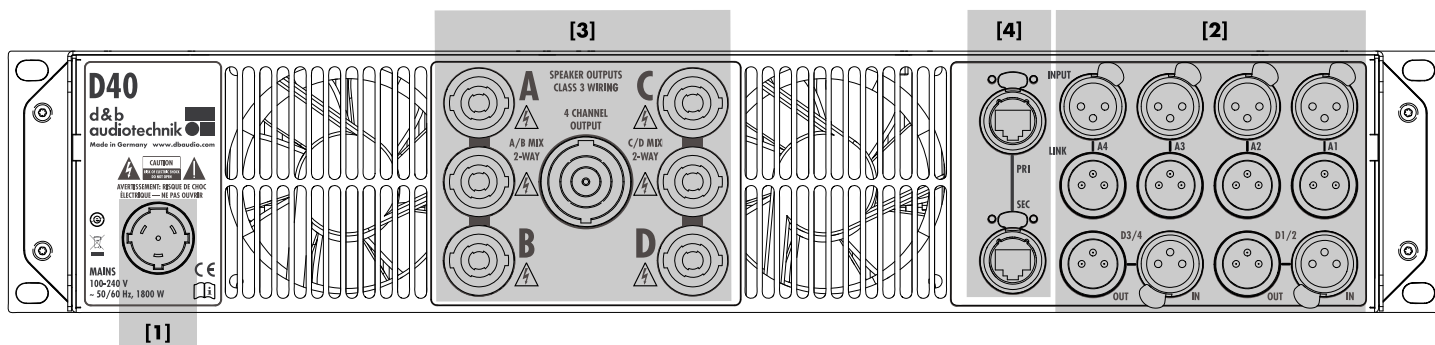

5.2.1 Mains connection



WARNING!

Potential risk of electric shock or fire.

The device is a protective class 1 unit. A missing earth (ground) contact may cause dangerous voltages in the housing and controls and may lead to electric shock.

- Connect the device to mains power supplies with protective earth only.
- If there is any sign of obvious damage to the power cord and/or mains plug, do not use the power cord and replace it before further use.
- Please ensure the mains connector is accessible at any time to disconnect the device in case of malfunction or danger. If the mains plug is not readily accessible due to mounting in a 19" rack, then the mains plug for the entire rack must be readily accessible.
- Do not connect or disconnect the mains plug under load.

Before connecting the device to mains voltage, check that the mains voltage and frequency correspond to the specifications on the rating label next to the mains connector socket on the rear panel of the unit.

Mains voltage range:

100 to 240 VAC, ~50/60 Hz, 1800 W.

A powerCON® TRUE 1 TOP mains connector socket [1] is fitted on the rear panel and an appropriate power cord [1.1] is supplied.

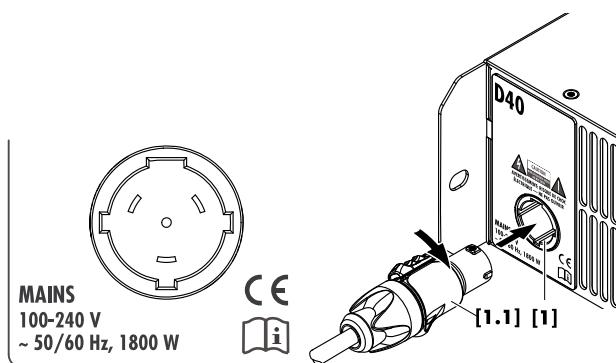

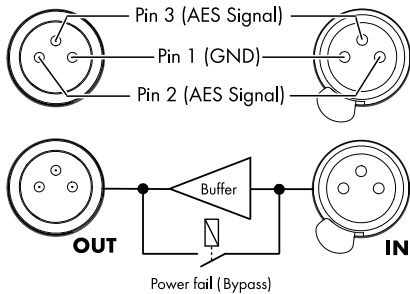
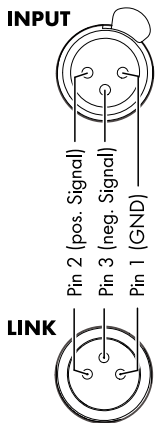
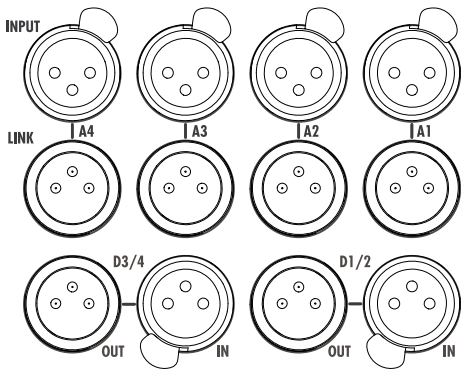

5.2.2 Audio input and output connectors

The rear panel features eight audio input connectors with the following assignments:

- four analog inputs (A1 - A4) with corresponding link outputs.
- two digital AES3 inputs (D1/2 and D3/4 - four channels) with corresponding outputs.

Each input channel can be routed to any of the output channels A to D ⇒ Input routing.

Analog INPUT and LINK (A1 - A4)

A 3-pin female XLR input connector is provided for each channel. Wired in parallel is a 3-pin male XLR input link connector used to feed the input signal onto the next device in the signal chain.

Specifications

Pin assignment	1 = GND, 2 = pos., 3 = neg.
Input impedance	32 kOhms, electronically balanced
CMRR @ 100 Hz/1 kHz / 10 kHz	>80 / >80 / >70 dB
Maximum input level (balanced/unbalanced)	+25 / +18 dBu
.....	+27.3 dBu @ 0 dBFS
LINK (A1 - A4)	3 pin XLR male
.....	parallel to input

Digital input and output (IN/OUT - D1/2 - D3/4)

Two 3-pin female XLR digital input (IN) connectors (D1/2 and D3/4) are provided, each accepting a 2-channel AES (AES3) digital audio signal.

The corresponding 3-pin XLR male digital output (OUT) can be used to feed a refreshed input signal to the next device in the signal chain. The signal shape (the rising and falling edges of the signal) and level are refreshed using a latency free analog buffer amplifier.

A power fail relay is incorporated to prevent interruption of the signal chain should there be a power failure. In this situation, the digital input signal bypasses the analog buffer amplifier and is routed directly to the output (OUT).

Specifications

Pin assignment	1 = GND, 2 = AES Signal, 3 = AES Signal
Input impedance	110 ohms, transformer balanced
Sampling frequency	44.1 48 96 192 kHz
Word length	16 - 24 bit
OUT (D1/2 - D3/4)	3-pin XLR male
.....	electronically balanced
.....	analog signal buffering (refresh)
.....	Power Fail Relay (Bypass)

5.2.3 SPEAKER OUTPUTS

WARNING!
Potential risk of electric shock.

The amplifier output pins can carry dangerous voltages.

- Only use isolated loudspeaker cables with correctly fitted connectors.
- Never connect an amplifier output pin to any other input or output connector pin or protective earth (ground).

The amplifier is supplied with four NL4 output connectors (A/B/C/D) one for each amplifier output channel ⇒ Dual Channel configuration.

In addition, two NL4 connectors are provided, one for each pair of amplifier output channels to allow either Mix TOP/SUB (A/B MIX, C/D MIX) or 2-Way Active (2-WAY/2-Way) configurations.

All NL4 connector pins are hardwired and permanently driven using the following pin assignments:

SPEAKER OUTPUTS pin assignments

AMP	SPEAKER OUTPUTS					
	A	B	A/B	C	D	C/D
A	1+/1- 2+/2-		1+/1-			
B		1+/1- 2+/2-	2+/2-			
C				1+/1- 2+/2-		1+/1-
D					1+/1- 2+/2-	2+/2-

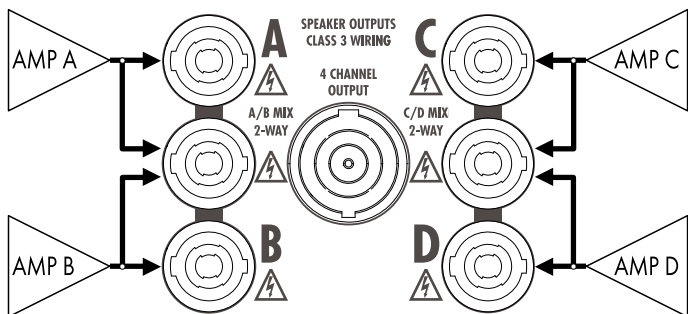

Output modes and connector assignments - exemplary

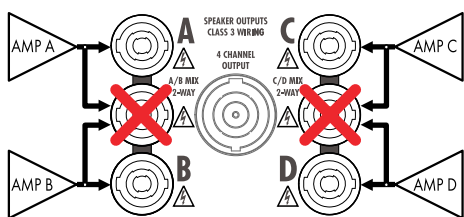

Dual Channel - Dual Channel
A/B - C/D

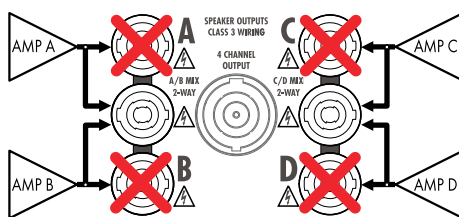

Mix TOP/SUB - Mix TOP/SUB
A/B MIX - C/D MIX
 or...
2-Way Active - 2-Way Active
2-WAY - 2-WAY

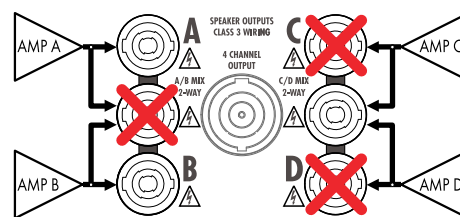

Dual Channel - Mix TOP/SUB
A/B - C/D MIX
 or...
Dual Channel - 2-Way Active
A/B - 2-WAY

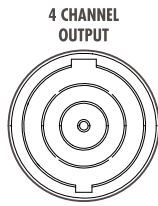

4 CHANNEL OUTPUT

NOTICE!

The 4 CHANNEL OUTPUT connector is only intended as an interface to a rack panel or to loudspeaker multicores and breakout adapters.

Do not connect any loudspeaker cabinet, neither passive nor active systems, to this connector, otherwise there is a risk of damaging the loudspeaker components or the amplifier.

The centered NL8 connector carries the output signals of all four amplifier channels with the following pin assignment:

1+/- = Channel A pos. / neg.	2+/- = Channel B pos. / neg.
3+/- = Channel C pos. / neg.	4+/- = Channel D pos. / neg.

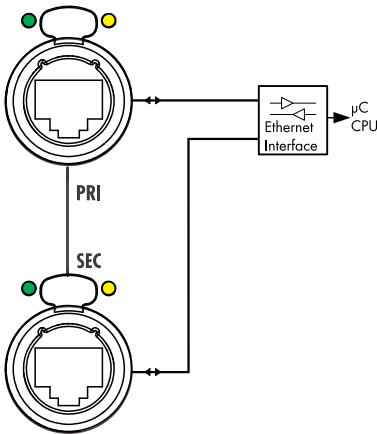

5.2.4 Network connections (PRI/SEC)

NOTICE!

Only **shielded network** cables (**STP**) must be used!

The device allows standard remote control via the d&b Remote network using the d&b R1 Remote control software or the integrated Web remote interface.

For this purpose, use the upper RJ45 (**PRI**) connector socket (1 Gbit/s/100 Mbit/s – peer-to-peer) requiring star topology network wiring. Daisy-chaining is not supported.

Note: The bottom RJ45 connector socket (**SEC**) is not enabled but is reserved for future feature implementations.

Gbit Ethernet

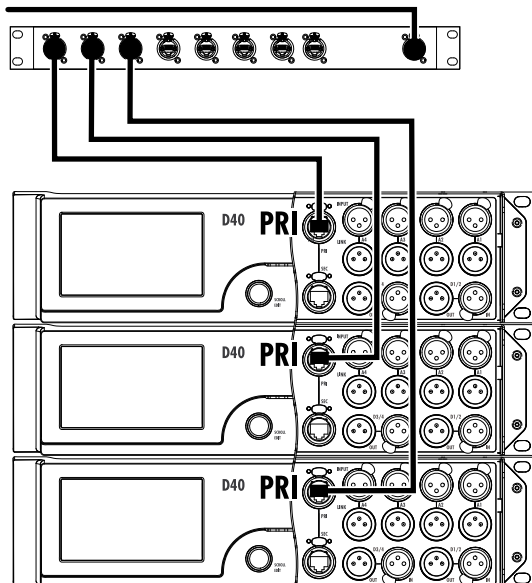

LED indicators

The two LED indicators above the respective connector in use indicate the following states:

- Green** Illuminates permanently when the device is connected to an active network and flashes as long as a data stream is transmitted.
- Yellow**
 - Is off when the speed is 100 Mbit/s.
 - Illuminates permanently when the speed is 1 Gbit/s.

5.3 Controls and indicators

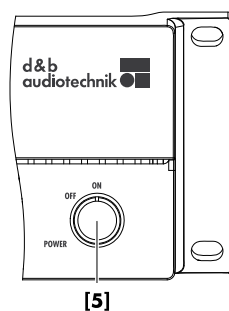
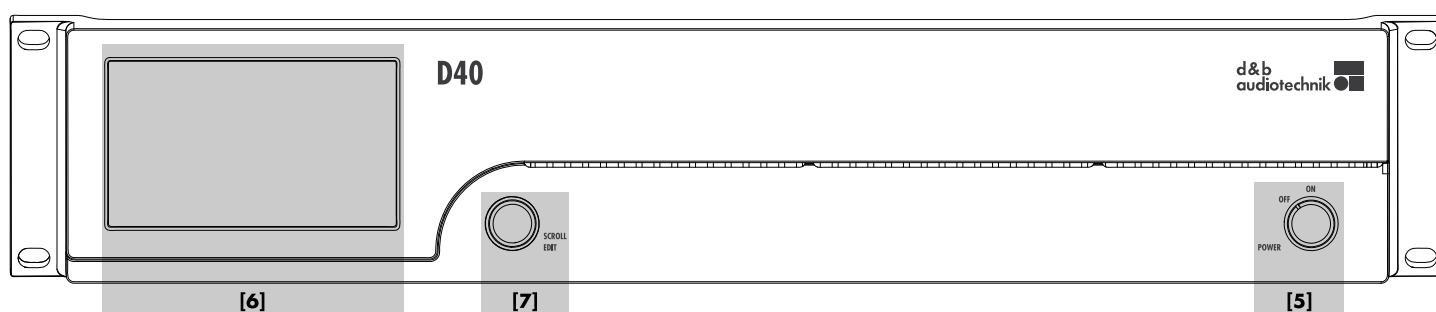

5.3.1 Mains power switch

The on/off rotary switch [5] is located on the bottom right of the front panel.

- OFF** Mains isolation is not provided. The internal power supplies are off but remain connected to the mains.
- ON** The unit is switched on and ready for operation.

5.3.2 TFT color touchscreen - User interface

NOTICE!

The touch panel utilizes a thin flexible sheet that may be damaged by sharp objects or heavy treatment.

The user interface consists of a 4.3" TFT color touchscreen [6] with a resolution of 480 x 272 pixels and an additional digital rotary encoder [7].

The resistive touchscreen responds to pressure and therefore can be operated by a fingertip, even when wearing gloves or by an appropriate stylus tip (pen).

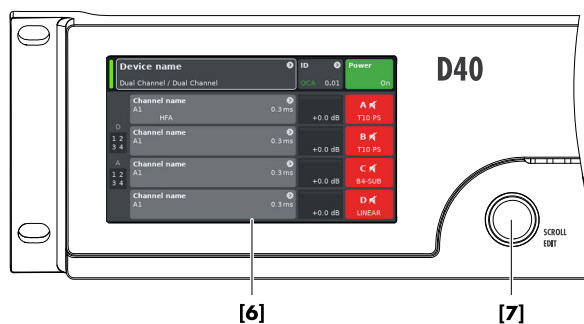

5.3.2.1 Operating concept

Home screen

From the Home screen, the menu structure of the operating software is divided into two main axes, the «Device» setup and the «Channel» setup.

The navigation buttons allow for direct vertical access to the specific submenus while the tab structure on the right side of each submenu provides a clear horizontal order.

In addition, the Home screen gives direct access to the Network subscreen.

The Home screen can be accessed from any screen or menu at any level using the Home button (🏠).

Device name		ID	Power
Dual Channel / Dual Channel		OCA 0.01	On
D 1 2 3 4	Channel name A1 HFA	0.3 ms	+0.0 dB A T10 PS
	Channel name A1	0.3 ms	+0.0 dB B T10 PS
	Channel name A1	0.3 ms	+0.0 dB C B4-SUB
	Channel name A1	0.3 ms	+0.0 dB D LINEAR

Home screen access chart Hierarchy level

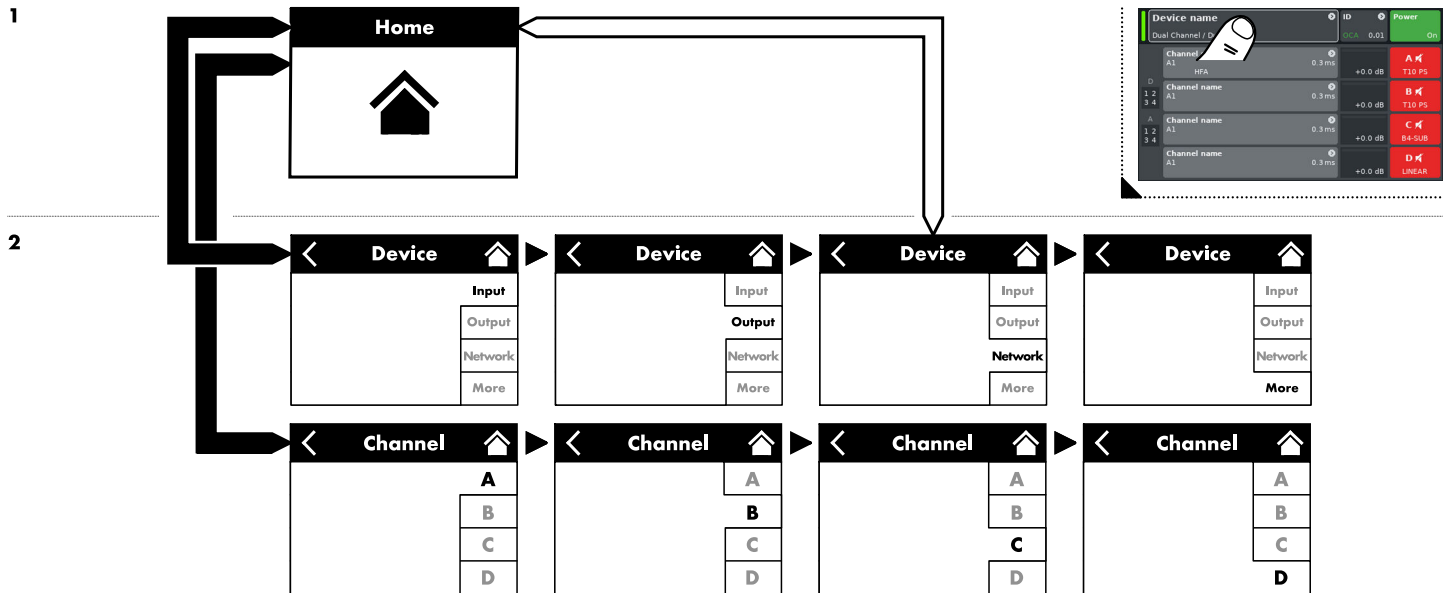

Cursor conventions

The graphical user interface features two types of cursors, the «Position» and the «Edit» cursors.

Position cursor



The Position cursor marks the selected menu item by a white frame. Depending on the type of screen item, the Position cursor allows you to either activate a function, navigate through the menu or enter Edit mode ⇒ Edit cursor.

Edit cursor

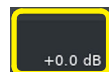

In Edit mode, the Edit cursor is marked by a yellow frame. Turning the encoder to the right (clockwise) increases the current value, turning the encoder to the left (counterclockwise) decreases it.

To leave Edit mode press the encoder or simply select the respective menu item again. The color of the frame will change from yellow back to white again ⇒ Position cursor.

Interaction

The operating concept allows different methods of interaction and configuration.

Touchscreen in combination with the rotary encoder

This method may preferably be used to set values of input fields such as Gain settings, CPL, Delay or EQ settings.

- Select menus, menu items and/or function elements by selecting the relevant item.
- Enter/edit values by turning the encoder.
- Confirm entered/changed values by selecting the respective item again or the confirmation button («OK») or pushing the encoder.

Rotary encoder only

This method is mainly intended for users who are familiar with the user interfaces of other d&b amplifiers.

- Select menus, menu items and/or function elements by turning the encoder to move the Position cursor to the relevant item.
- Access the selected item or function element by pushing the encoder.
- Enter/edit values by turning the encoder.
- Confirm entered/changed values or leave Edit mode by pushing the encoder.

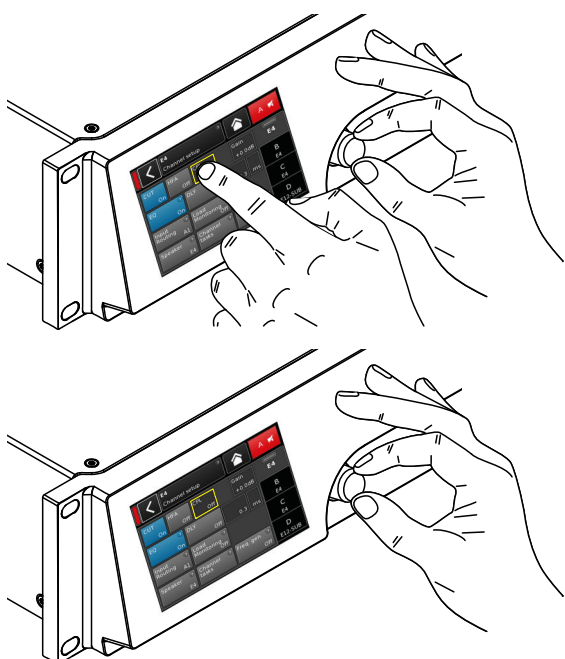
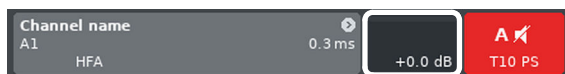



5.3.2.2 Standby mode

To switch the device to Standby mode, proceed as follows:

1. Select the «Power» button on the top right of the home screen.
 - ↳ A dialog appears allowing you to either select the Back button (⏪ - Cancel), «Mute all» or «Standby».



2. Select «Standby».
 - ↳ When the device is in Standby mode, both the «Power» button on the right and the green Power on indicator on the left are switched off. In addition, on the «Device view» button, Standby flashes alternating with the Device name.

In Standby mode, the user interface of the device is still operable.

The operating state (Standby mode) is stored when the «Power» button is set to 'Off' and is restored when the «Power» button is set back to 'On' again.

In Standby mode, the main power supply and the power amplifiers are switched off to save energy. The display and controls remain active to allow repowering of the device by remote control or by selecting the «Power» button on the Home screen.

3. To repower the device, select the «Power» button again.

Notes on Standby

When the device is set to Standby (or the mains power is switched off), the movement of the loudspeaker cones in the connected cabinets is no longer damped by the power amplifier output. This removal of the damping makes them susceptible to excitation by other loudspeakers in the surroundings. Audible resonances may occur, and even absorption of low frequency sound energy as the undamped loudspeakers act like a "bass trap".

To permanently mute single subwoofer cabinets while others are operated at the same time it is therefore preferable to use the Mute function instead of Standby. However, the Standby mode can be useful with mid/high systems as it removes any residual noise from the system.

5.3.2.3 Mute functions

The device provides two mute functions:

- Individual mute buttons for each channel or pair of channels, depending on the output mode configuration:
 - ⇒ Channel mute,
- Master mute function:
 - ⇒ «Mute all».

Note: The device stores the setting of the mute buttons when the mains power is switched off or disconnected. When the unit is switched on or reconnected, the mute status will be recalled.

Channel mute

- ⇒ To mute or unmute a channel or a pair of channels, simply select the respective Channel mute button.
- ↳ The Channel mute button displays the mute status of the relevant channel or pair of channels and the loudspeaker setup loaded.



Channel muted

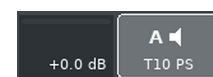

Channel unmuted

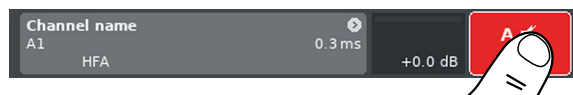

Master mute («Mute all»)

1. To mute all channels simultaneously, select the «Power» button on the top right of the Home screen.
 - ↳ A dialog appears allowing you to either select the Back button (⏪ - cancel), «Mute all» or «Standby».
2. Select «Mute all».



3. To unmute the channels, use the individual Channel mute buttons.

Device setup access chart

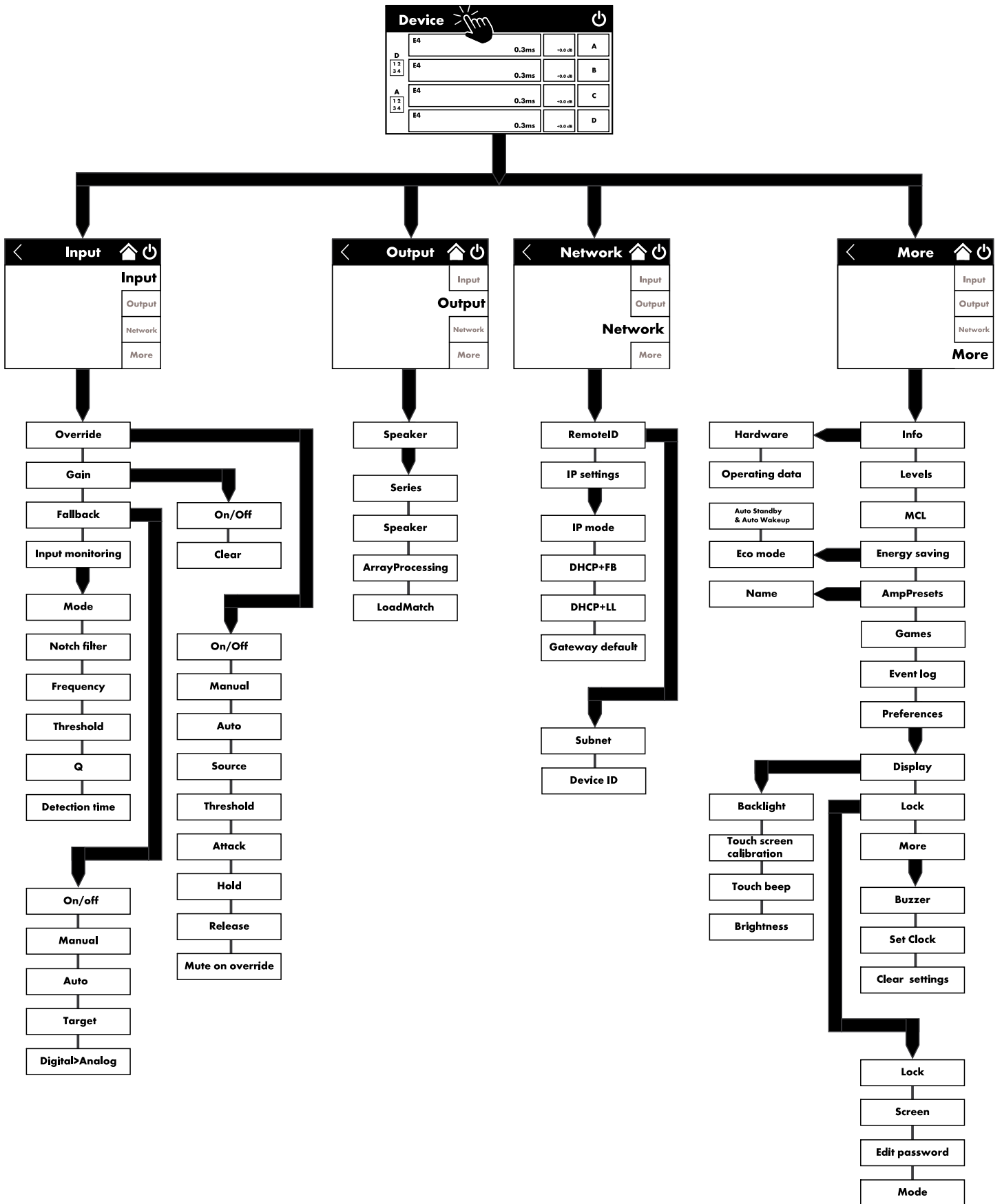



From the home screen, select the device view button to open the device setup screen with the active «Input» tab.

The device setup screen follows the same layout structure as shown in the graphic above and is split into the header and the data section.

Use the tabbed structure of the device setup screen to get direct access to the subscreens.

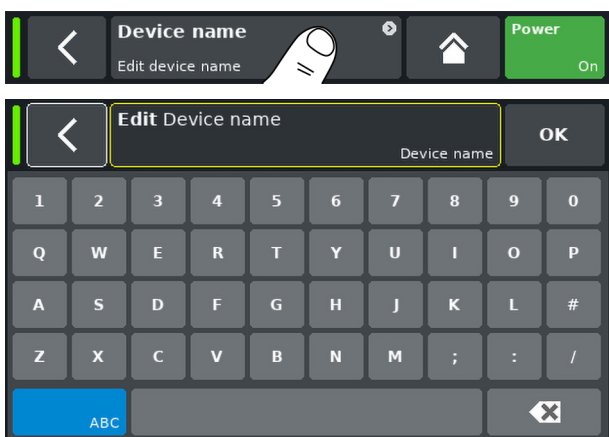

6.1 Device name

Select the centered information field button («Edit device name») in the header of the device setup screen to enter or edit the device name (maximum length 15 characters).

The input mask which appears allows either lower-case or upper-case characters by toggling the corresponding button («ABC») on the bottom left.

To correct wrong entries, tap the erase button (✕) on the bottom right.

Tap «OK» on the top right to confirm the entry. This closes the input mask and switches back to the device setup screen.

Tap the back button (◀) on the top left to cancel any entries. This will also take you back to the device setup screen and will keep the previous entry.

6.2 Input

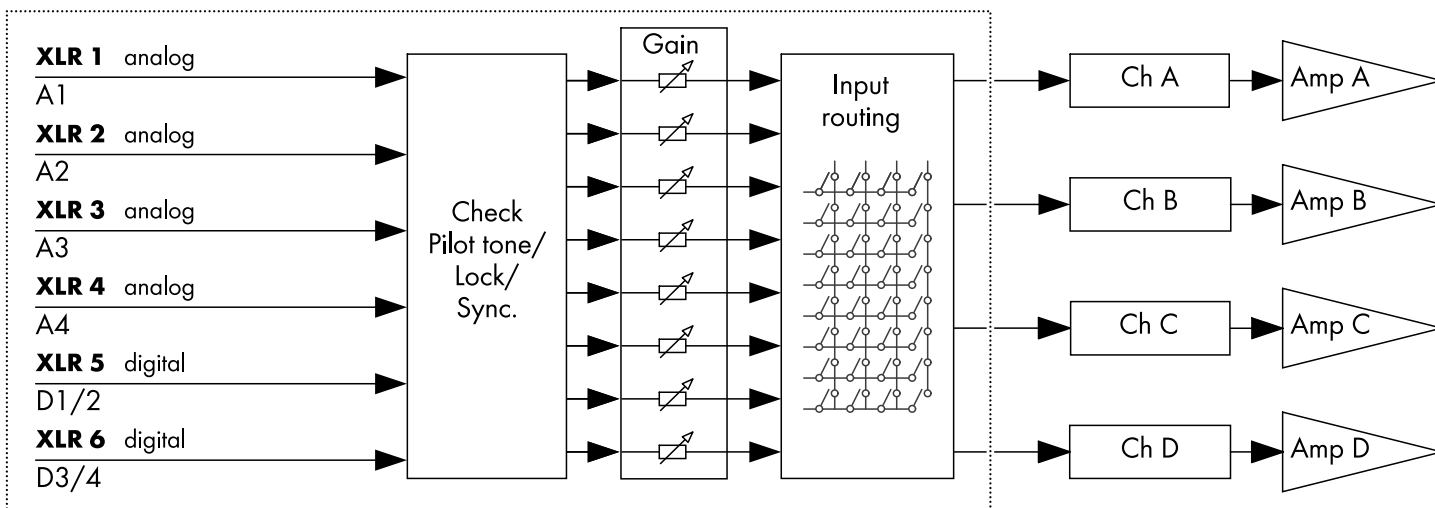

Input configuration

The «Input» tab offers the complete input management in one place where you can configure dedicated input settings, such as:

- ⇒ Input monitoring (Mon)
- ⇒ Input gain (Gain)
- ⇒ Fallback
- ⇒ Override

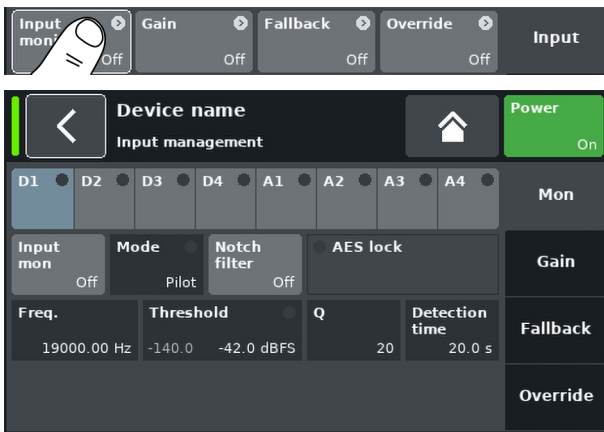
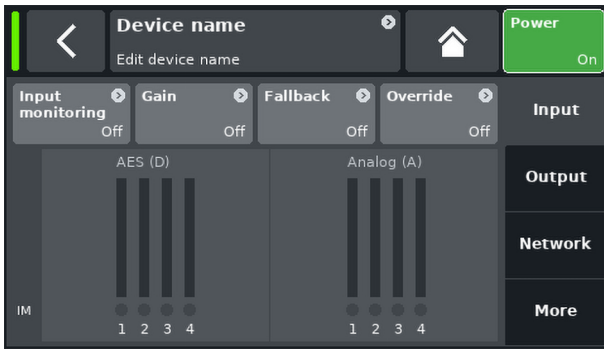

6.2.1 Input management

The «Input» screen provides access to the following input-related functions:

- Input monitoring (Mon)
- Input gain (Gain)
- Fallback
- Override

The on/off status of each function is indicated by change in color of the button from gray to blue or vice versa.

Below these buttons, there is a graphical representation of the actual input level and input monitoring.

6.2.1.1 Input monitoring

Select «Input monitoring» from the input management menu to open the submenu.

The input monitoring function enables the amplifier to monitor all signals, either from analog and/or digital signal sources, fed to the respective input (⇒ «Input»). If one or several signals fail, a corresponding error can be generated and reported.

At the signal source, an additional external pilot signal (sine wave signal) is added (summed) to the source signal.

Within the amplifier, this pilot signal can be detected (⇒ «Mode» ⇒ «Pilot») using an adjustable bandpass filter (⇒ «Freq.»).

As long as the pilot signal is permanently and safely present within the given pilot band, this is an indication that the incoming signal path is faultless.

For this purpose, the amplifier determines the level of the pilot signal within the pilot band. The result is then compared with an adjustable reference threshold set by the user (⇒ «Threshold»). If the level of the pilot signal falls below the reference threshold, a time-related error can be generated (⇒ «Detection time»).

The pilot signal can be removed from the source signal (program signal) at any time using a notch filter (⇒ «Notch filter»).

When input monitoring is used with digital inputs, it is also possible to detect whether the device has locked to the digital source signal or not (⇒ «Mode» ⇒ «Lock»).

Finally, the Input monitoring mode «DS data» permanently monitors the meta data information sent by a d&b DS-Series device.

Input monitoring settings

Input Input selector (D1 - D4, A1 - A4).

Mode Depending on the selected input (analog or digital), the following mode settings are available:

Input	Mode		
	Pilot	Lock	DS data
A1 - A4	Yes	No	No
D1 - D4	Yes	Yes	Yes

Input monitoring

You can select and set every channel individually. See the table above for all available channel modes.

The error status is also indicated on the «Home» screen. A corresponding message (Input monitoring fault) will be issued.



Frequency

The center frequency of the pilot band, adjustable from 5 Hz to 24 kHz in 1 Hz or 0.01 Hz increments. The chosen increment is shown in light grey at the top right of the field. Select the field to toggle between the different increments 1 Hz and 0.01 Hz.

Note: The set frequency also applies to the notch filter.

Threshold

Detection threshold for an external pilot signal of the set frequency, adjustable in the range from:

- Analog signals: -117 dBu to +21 dBu in 1 dB increments
- Digital signals: -137 dBFS to 0 dBFS in 1 dB increments

On the bottom left of this field, the actual level is displayed in light gray while the set threshold is displayed on the bottom right. Once a pilot signal is detected, the corresponding LED indicator at the top right illuminates green.

Quality

The Q of the notch filter, adjustable from 4 to 42 in increments of 1. The center frequency is fully attenuated ($\Rightarrow -\infty$ dB).

Detection time

The maximum time interval that is allowed for an interruption of the monitored pilot signal or digital clock (Lock) without an error message being generated (0.1 ... 99.9 sec. in 0.1 sec. increments).

Notch filter

Notch filter to remove the pilot signal from the program signal. However, if activated, the notch filter remains active even if Input monitoring is set to Off.

6.2.1.2 Input gain

Select «Gain» from the «Input management» menu to open the subscreen.

An additional preamplifier stage (gain pot) is provided for each input channel, either analog or digital.

This allows either analog or digital audio sources to be directly connected to the respective amplifier input channels and presets their upstream gain ranging from -57.5 dB to +6 dB in steps of 0.5 dB.

By factory default the input gain is set to 0 dB.

Two buttons are provided on the left side of the screen:

- Input gain** Master On/Off switch. The on/off status is indicated by a change in color of the button from gray to blue or vice versa.
- Clear** All gain settings are reset to factory default (0 dB) while the function remains activated.

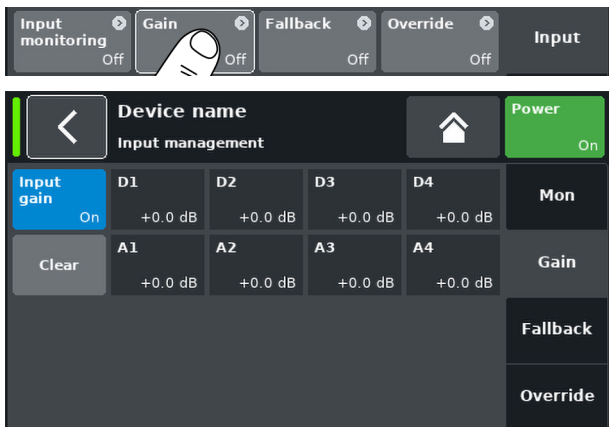

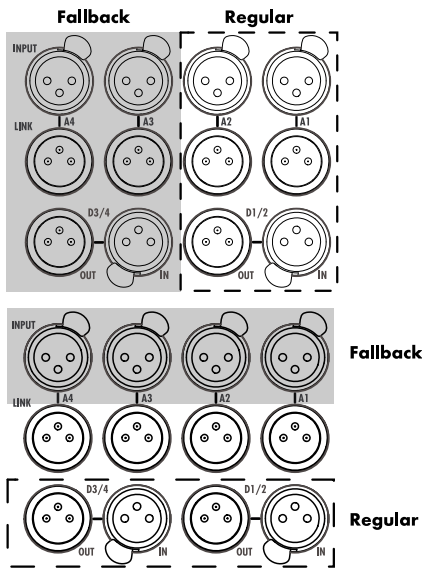

Fallback targets: A1,A2 > A3,A4
Fallback targets: Digital > Analog

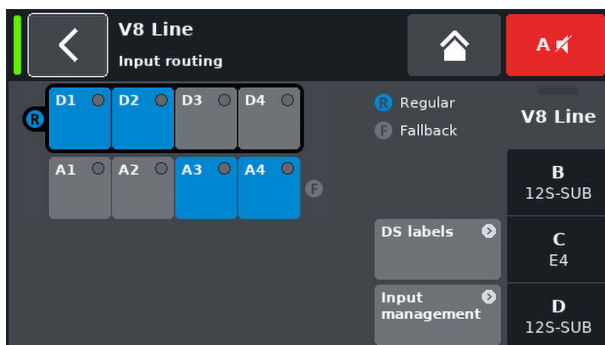
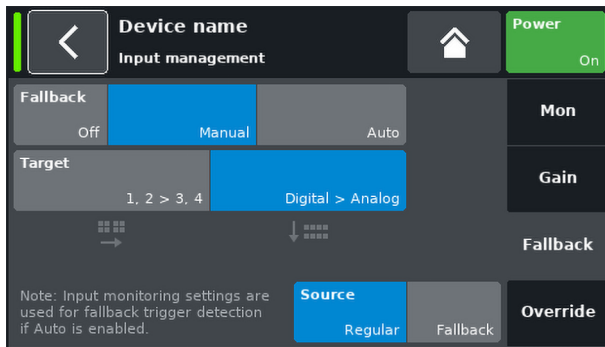

6.2.1.3 Fallback

The fallback function enables the definition of primary (Regular) and secondary (Fallback) signal paths for analog and digital input signals with two different modes (Manual or Auto). This ensures that any secondary or emergency signal fed to the fallback inputs is transmitted when required.

Note: The fallback and override functions can be used simultaneously. However, please note that in this case the chosen override input channel is no longer available as fallback input.

Selecting «Fallback» from the «Input settings» menu opens the corresponding subsection.

Off When this button is activated (blue), the «Fallback» function is disabled.

The On/Off status is also displayed on the «Device setup» screen.

Manual You can select the desired signal path manually («Source») either locally or via the Web Remote interface or via the d&b Remote network using R1.

Auto Activate and parameterize Input monitoring («Mon») to enable the automatic switch (see chapter => Chapter 6.2.1 "Input management" on page 26 for more information about parameterizing). After the Fallback function has been triggered, you can reset it manually by selecting the «Regular ½» input source.

This can be done either locally or via the Web Remote interface or via the d&b Remote network using R1.

When the Fallback function is activated, the input routing screen is divided into two groups, «Regular» and «Fallback». Both groups can be selected as the source.

1,2 > 3,4 Select any combination of A1, A2, D1, D2 as your regular input(s).
 Select any combination of A3, A4, D3, D4 as your fallback input(s).

Digital > Analog You select from the complete row digital or analog as regular or fallback.

Note: The input routing settings are stored when the device switches to fallback mode. When the fallback mode is deactivated (either manually or automatically), the last input routing settings defined are restored.

6.2.1.4 Override

The override function is available for input channels.

The override function allows to set an input channel as a major signal path. When the function is activated, the input channel has the highest priority for general messages or emergency services.

When override is activated, the corresponding input channel is disabled on the input routing screen and «Override» is displayed (flashing when active).

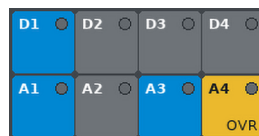

Select «Override» from the «Input management» menu to open the corresponding subscreen.

Off

When this button is activated (blue), the «Override» function is disabled. The On/Off status is also displayed on the «Input management» screen.

Manual

You can select the desired signal path manually («Source») either locally or via the Web Remote interface or via the d&b Remote network using R1.

Auto

Select «Auto» mode to permanently monitor the selected input channel. As soon as the incoming signal level exceeds the defined threshold, the selected input channel will be opened depending on the set attack time. All other inputs will be muted (gate + ducking). As soon as the signal level drops below the threshold, the selected input channel will be muted while all other channels will be unmuted depending on the set hold and release times (crossfade).

Threshold

Threshold level, adjustable from -42 dBu to +25 dBu in 1 dBu increments. On the bottom left, the actual level of the incoming signal is displayed in light gray. In addition, an LED indicator is provided on the top right. As long as the incoming signal level is below the set threshold, the LED illuminates yellow and changes to green as soon as the level exceeds the threshold.

Attack

Attack time, adjustable from 0.01 sec. to 1 sec. in 0.01 sec. increments.

Hold

Hold time, adjustable from 0 sec. to 10 sec. in 0.1 sec. increments.

Release

Release time, adjustable from 0 sec. to 10 sec. in 0.1 sec. increments.

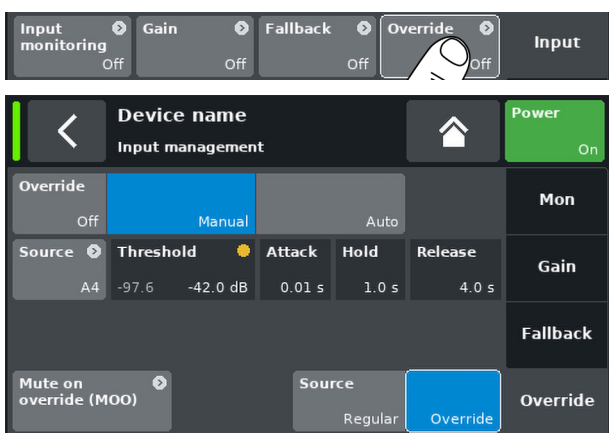

6.3 Output

NOTICE!

Ensure that the connected loudspeaker type corresponds to the actual output configuration of the amplifier.

See chapter ⇒ Chapter 5.2.3 "SPEAKER OUTPUTS" on page 17 for the wiring of the power amplifier channels to the output sockets.

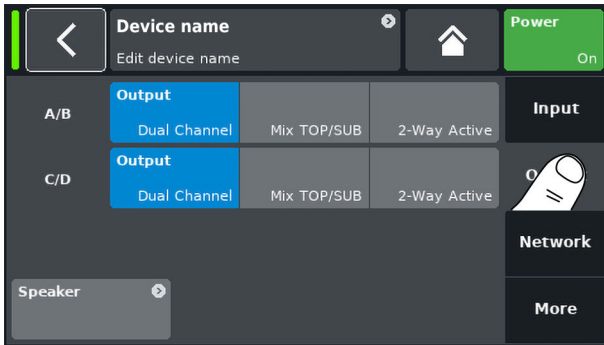

Select the «Output» tab to assign the output mode to a pair of amplifier output channels (AMP A/B and/or AMP C/D).

The following output modes can be assigned to a pair of amplifier output channels (AMP A/B and/or AMP C/D).

- Dual Channel
- Mix TOP/SUB
- 2-Way Active
- Mixed configurations

⇒ A change of the output mode must be confirmed. This is done by selecting either the Back (◀) or the Home (🏠) button.

- ↳ The set output mode is activated and the corresponding channels are muted.

Note: Changing the output mode affects the available range of loudspeaker setups.

On the home screen, the selected output mode is displayed in the header area below the device name.

The channel strips below the header section change depending on the chosen modes as shown below.

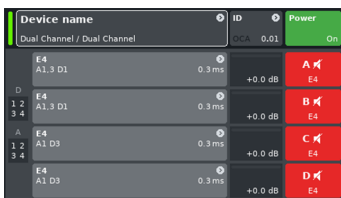

2 x Dual Channel

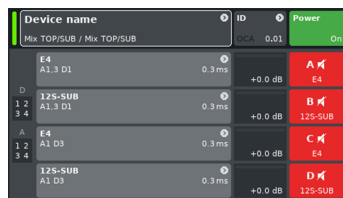

2 x Mix TOP/SUB

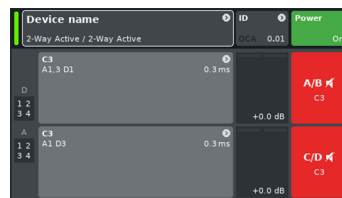

2 x 2-Way Active

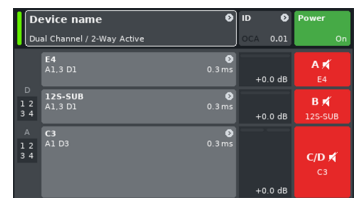

Mixed configuration



On the bottom left of the Output screen, the «Speaker» navigation button provides direct access to the Speaker setup screen.

6.4 Network

Select the «Network» tab to assign remote settings for Ethernet remote control.

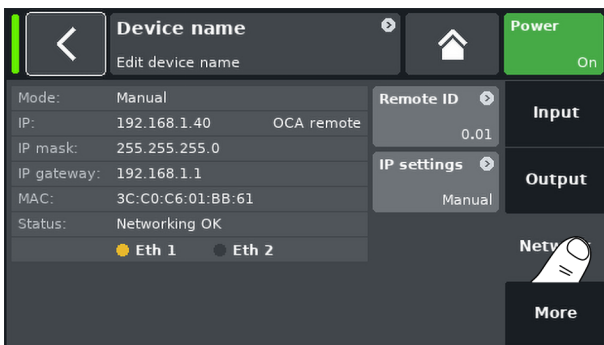



6.4.1 IP settings

Select the navigation field «IP settings» to enter the corresponding subscreen. In addition, the «IP mode» is displayed on the upper right of the navigation field.

IP mode

Selecting this field enables the following settings:

Manual

Allows the manual assignment of IP settings.

DHCP+FB

When the device is connected to a network with a DHCP server present, a matching IP address is assigned automatically. If no DHCP server is present on the network, the IP will fall back (FB) to the manual IP addressing.

DHCP+LL

IP mode for using Link-Local addressing.

When a DHCP server is present, the IP address is assigned automatically by that server. If this fails, an address will be assigned automatically using the Link-Local address in the range from 169.254.0.1 to 169.254.255.254. All devices in a local network will ensure that their IP addresses are unique. After the Link-Local configuration is completed, a fully functional network will be available. If a DHCP server is available later, an automatic IP will be automatically assigned later.

Link-Local addressing is the default behavior of every PC and MAC computer when no DHCP server is present. The DHCP+LL setting enables the amplifier to also work in a setup without a DHCP server. A fully functional local network including remote control from a PC or Mac via R1 will be set up automatically.

Note: Please note that IP addresses in the Link-Local range (169.254.0.0/16) cannot be assigned manually.

IP address IP mask IP gateway

Provided the IP mode is set to «Manual», selecting either field opens a numerical input mask and allows you to enter the relevant data.

Wrong entries can be corrected by tapping the erase button (✕) on the upper right.

Select «OK» on the top right to confirm the entry, close the input mask and switch back to the «Network» screen.

Select the back button (⏪) on the top left to cancel any entry and switch back to the «Network» screen keeping the previous entry.

Set gateway to default

When this button is selected, the gateway address is derived from the IP address and IP mask settings.

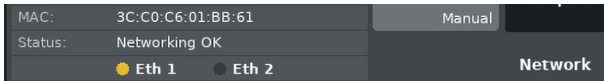

MAC: Displays the fixed MAC address of the device.

Status: Shows which of the etherCON connectors is connected (busy).

Provides status information on the network:

- < 1 Gbit/s
- = 1 Gbit/s

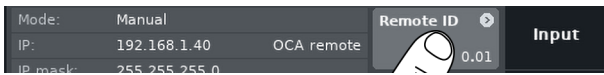

6.4.2 Remote ID

Select the «Remote ID» button to set the unique remote identifier of the respective device in the format [nn].[nn].

Subnet

The first two digits represent the subnet.

Subnet.Device ID

Within an **Ethernet network** up to 100 subnets can be defined (values 0 to 99).

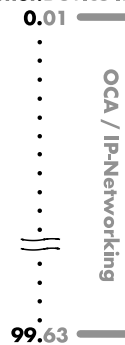

Note: In case of a subnet mismatch, the following message is issued at the bottom of the screen:

Remote ID exceeds 99.63

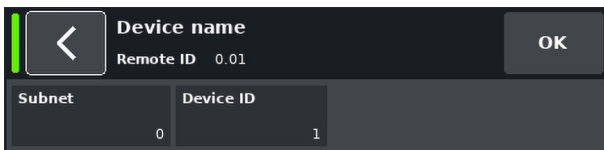

Device ID

Using the two digit Device ID for each subnet, you can define a total of 63 devices (values 1 to 63).



6.5 More

Selecting the «More» tab provides further subscreens such as:

- Preferences
- Info
- Levels
- Mains current limiter
- ...



6.5.1 Preferences

Select «Preferences» to open the corresponding subscreen with the «Display» tab being active.

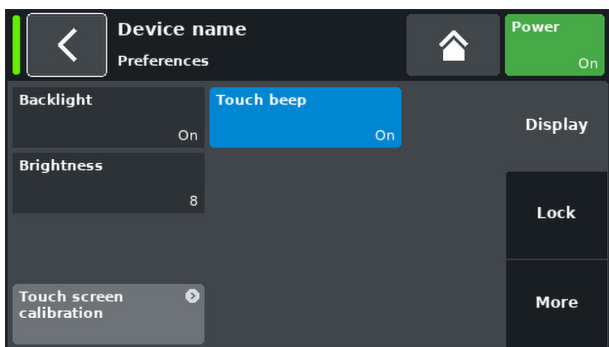

6.5.1.1 Display

The «Display» tab provides the following display options.

Backlight

Enables the following optional settings:

Off

The display brightness is set to 1 (minimum brightness).

On

The backlight is permanently on.

Timeout

10s

Illuminates the display when you press the encoder or select the display. The light switches off automatically 10 seconds after the last operation.

Note: This setting is recommended to increase the lifetime of the display.

Brightness

Adjusts the display brightness in the range from 1 to 10. The default setting is 8.

Touch beep

Enables or disables the beep sound when using the touch screen.

Touchscreen calibration

Due to mechanical impact or the aging process of the touch screen, its calibration references may change.

An indication is that when you tap a specific button and the adjacent button is activated instead or when a specific button does no longer work.

In such cases, the touch screen should be recalibrated.

To calibrate the touch screen, proceed as follows:

1. Select «Touchscreen calibration».
 - ↳ The Screen calibration menu will open guiding you through the calibration process.
2. Follow the relevant on-screen instructions.

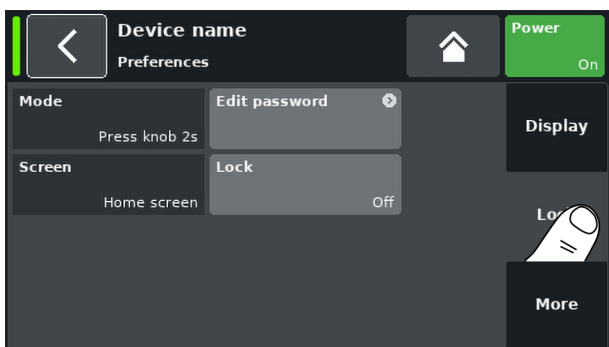

6.5.1.2 Lock

Select the «Lock» tab to open the corresponding subscreen which provides different protection settings.

Mode

Select «Mode» to toggle between two options to protect the device against unintentional operation.

Press knob 2s

Prevents accidental operation by locking the front panel controls.

Password

Password protection to prevent operation by unauthorized persons.

Screen

Select «Screen» to allow two different settings for the screen when the device is locked.

Home screen

Switches to the Home screen.

Levels

Switches to the Levels screen.

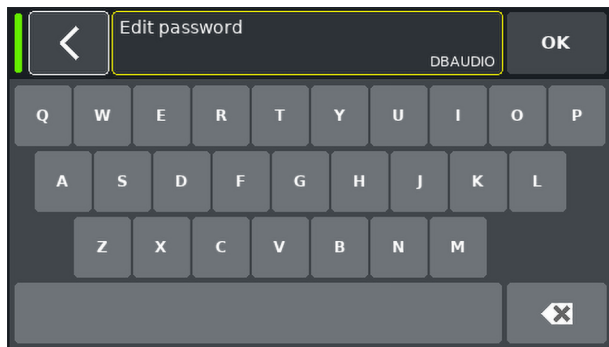

Edit password

Select the «Edit password» option to open an input mask which enables you to edit or assign a password (upper-case characters with a maximum length of 7 characters).

Wrong entries can be corrected by tapping the Erase button on the bottom right (X).

Tap «OK» on the top right to confirm the entry, close the input mask and switch back to the lock screen.

Tap the back button (←) on the top left to exit the input mask and leave the previous password unchanged.

Note: The factory default password is: dbaudio

Lock

Tap the «Lock» button to confirm any new settings and exit the subscreen. A corresponding message is displayed.

The device will be switched to the screen selected for lock mode.

Unlocking the device

If you attempt to change the status of the device while it is in lock mode, the following message will be issued: Press encoder for 2s to unlock. To unlock the device, proceed as follows:

- Press ...** Press and hold the encoder for a minimum of 2 seconds until the message disappears.
- Password**
 1. Press and hold the encoder for a minimum of 2 seconds until the corresponding input mask is displayed.
 2. Enter the password as described above. An incorrectly entered password will revert the device to the screen displayed for Lock mode.

If the password is lost or forgotten, a locked device can be unlocked by performing a system reset.

Note: All device preferences will be set to factory defaults except for the network (Ethernet) and fixed device settings. If you execute this procedure, no dialog will be prompted and the reset will start immediately.

To perform a system reset, proceed as follows:

1. Switch off the device.
2. Press and hold the encoder and repower the device.
 - ↳ Long confirmation beep.
3. Release the encoder and briefly press the encoder again within 2 sec.
 - ↳ Short confirmation beep.

The device will boot up and will switch to the home screen. A corresponding message will be issued:

All device settings have been cleared

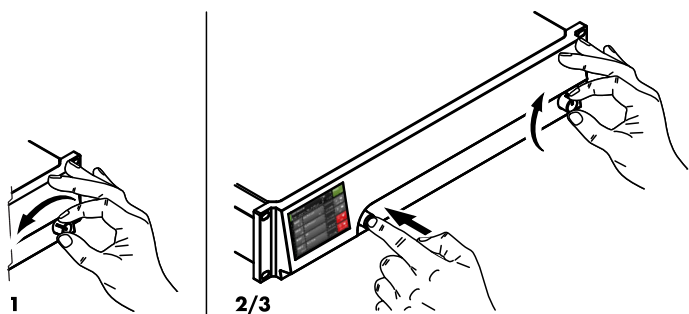

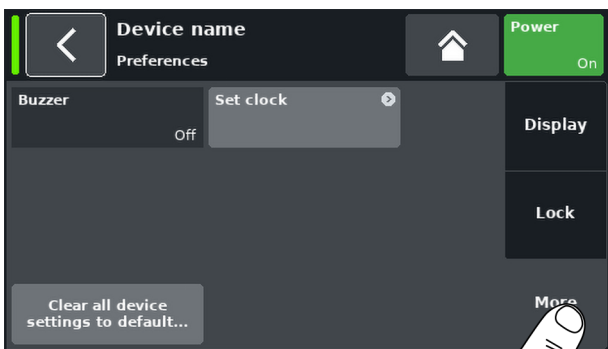

6.5.1.3 Preferences/More

Select the «More» tab to open the corresponding subscreen which provides the following options.

Buzzer

The internal buzzer serves as an acoustic signal in case of a device or channel error.

The following settings can be enabled:

- Off** The internal buzzer is switched off.
- On** The internal buzzer is switched on and generates an intermittent sequence of two equal tones.
- Single** The internal buzzer generates an intermittent single tone.
- Melody** The internal buzzer generates a predefined intermittent sequence of tones.

Set clock

Enables setting the internal clock while the current UTC (Coordinated Universal Time) date and time are displayed at the bottom of the screen.

Within a Remote network, the device's clock is synchronized to the UTC time of the connected R1 instance.

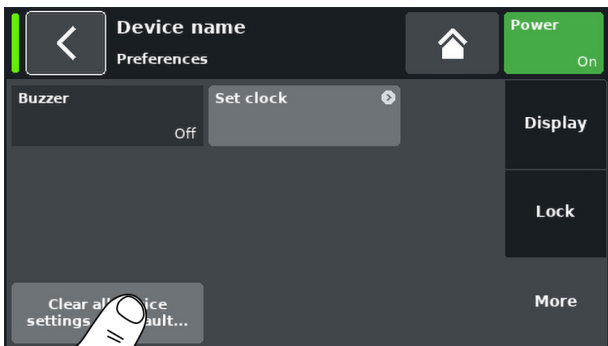
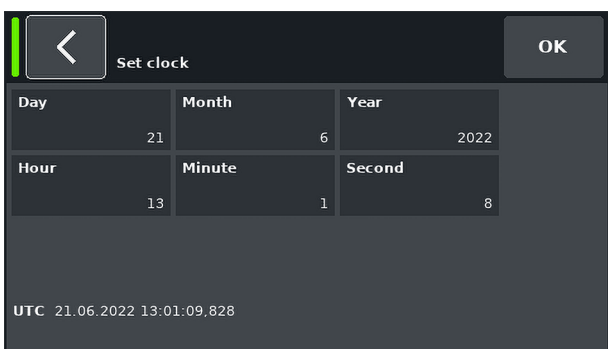

6.5.1.3.1 System reset

Selecting «Clear all device settings to default» resets all device settings to factory defaults except for the network (Ethernet) and fixed device settings.

To prevent accidental reset when you tap the «Clear...» button, a dialog will pop up prompting you to confirm the reset or cancel the sequence by tapping the Back button (⏪).

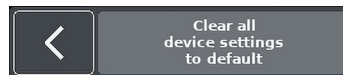

Alternative procedure

A system reset can also be triggered as follows:

Note: All device preferences will be set to factory defaults except for the network (Ethernet) and fixed device settings.

If you execute this procedure, no dialog will be prompted and the reset will start immediately.

1. Switch off the device.
2. Press and hold the encoder and repower the device.
 - ↳ Long confirmation beep.
3. Release the encoder and briefly press the encoder again within 2 sec.
 - ↳ Short confirmation beep.

The device will boot up and will switch to the Home screen. A corresponding message will be issued:

All device settings have been cleared

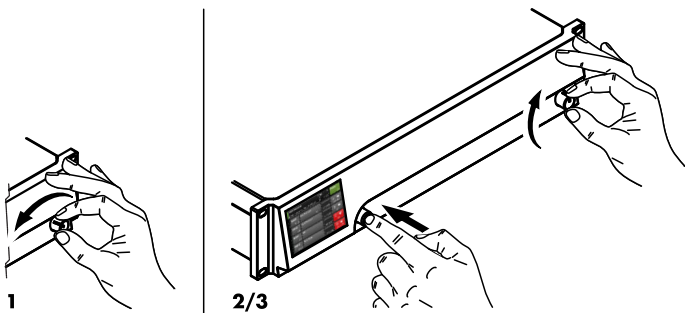

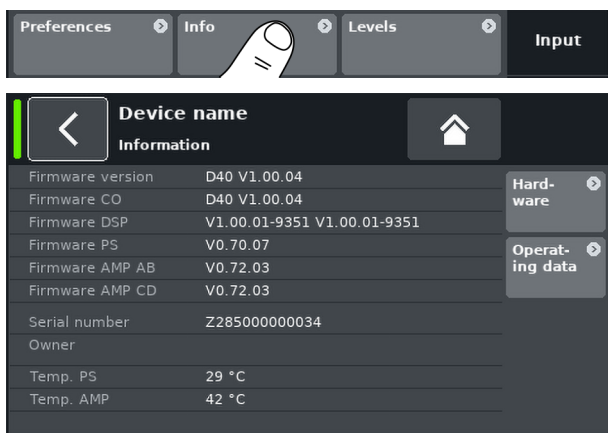

6.5.2 Info

Selecting «Info» provides basic information about the device.

The information provided is mainly intended for service purposes.

Most of the information is static information, for example:

- Various firmware versions (Firmware Core/DSP/PS/AMP)
- Serial number
- Owner

In addition, there is dynamic information about the actual temperatures of... :

- Power supply (Temp. PS)
- The entire power amplifier (Temp. AMP)

Selecting the «Hardware» button provides further hardware specific information.

Selecting the «Operating data» button provides further data, e.g. operating hours and number of startups.

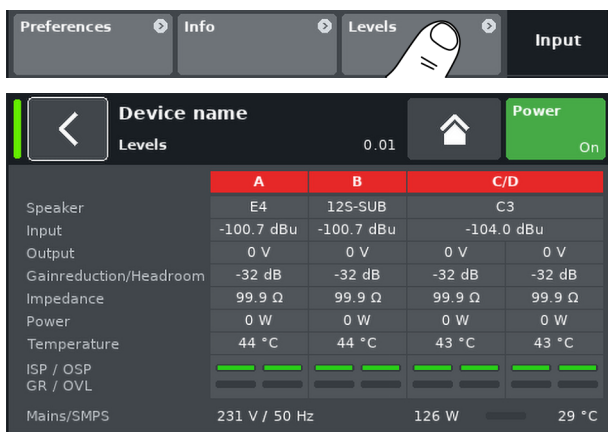

6.5.3 Levels

Selecting «Levels» opens the corresponding subscreen.

The data area of the levels screen provides the following information (starting from the top left):

- 1st line** Mute status of each channel.
- Speaker** Loudspeaker setups selected for the individual channels.
- Input** Actual input signal levels of the individual channels.
- Output** Actual output voltages of the individual amplifier channels.
- Gainred/Headr** Relationship between headroom (Headr) and gain reduction (Gainred) with peak hold for 1 sec.
Display ranges:
Gainred 0 dB ⇒ +32 dB.
Headr -32 dB ⇒ 0 dB.
- Impedance** Actual load impedance values for the individual amplifier channels.
- Power** Power actually delivered by the individual amplifier channels.
- Temperature** Actual temperatures of the individual amplifier channels.
- ISP/OSP** Indicates whether the input signal (ISP) as well as the amplifier output signal (OSP) of the individual channel are present.
- GR/OVL** Indicates whether gain reduction (GR) of the respective channel is active or the respective channel is overloaded (OVL).

Mains/SMPS Displays the actual mains voltage and frequency, the actual mains power consumption in combination with a power limiter LED and the actual temperature of the switched mode power supply (SMPS).

6.5.4 Mains current limiter (MCL)

Selecting «Mains current limiter» opens the corresponding subscreen.

The D40 features a power limiter which serves to limit the mains current draw whenever the mains current draw threatens to trigger the circuit breaker.

Limiting is done by reducing the sound levels evenly on all channels. This ensures that the tonal balance is kept.

The **M**ains **C**urrent **L**imiter function allows to set the maximum mains current draw of the device within the range of 95 to 50 % of the nominal limit.

The nominal current limit depends on the mains voltage range: 13 A in high range, 20 A in low range.

This may be useful when the onsite conditions require two devices to be operated per phase conductor or if the onsite circuit breaker is not sufficiently dimensioned.

On/Off Activates the additional limiter.

Mains current limit The maximum mains current draw is defined as a percentage value of the nominal current limit, as indicated above and can be set in the range from 95 % down to 50 % in steps of 5 %.

When the MCL is activated, the defined value is permanently displayed on the «Power» button on the Home screen.

Setting recommendations

No. of devices	Circuit breaker	MCL setting
1 x D40	13 A @ 230/240 V	Off
2 x D40	16 A @ 230/240 V	60 %

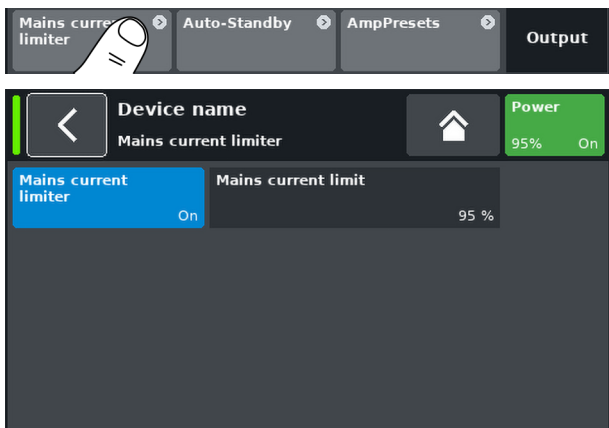

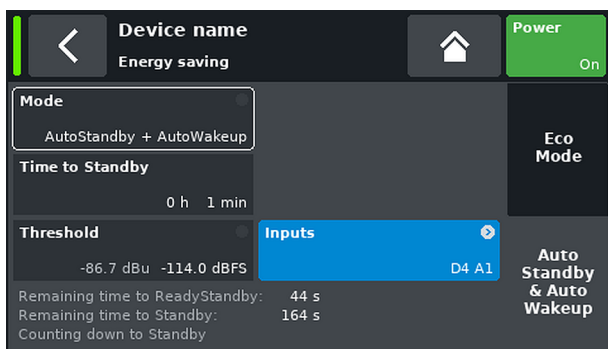
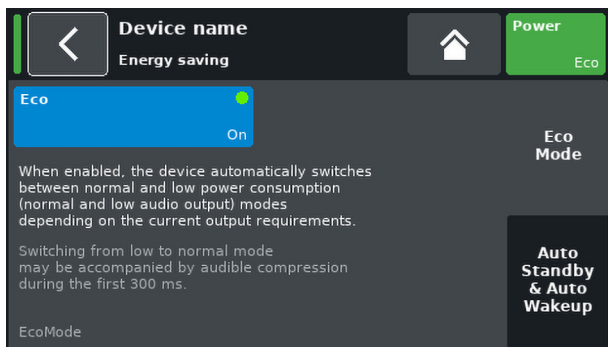

6.5.5 Energy saving

EcoMode

EcoMode enables the amplifier to automatically switch between normal and low power consumption modes depending on the current output level requirements. When enabled and the output level of all channels is continuously low, a 60 second countdown will be started, indicated by the message «Counting down to EcoMode» in the bottom left corner.

When the output signals has been low for the full 60 seconds, EcoMode will be activated and power consumption is reduced. This is indicated by the green LED on the «Eco» button, the text «EcoMode» in the bottom left corner and the text «Eco» on the power button.

In EcoMode, the amplifier still outputs the audio input signals. Once the output level of any channel exceeds the amplifier's capabilities in EcoMode, the amplifier automatically switches back to normal operation without interruption of the audio output signals.

Note: Switching from low to normal mode may be accompanied by audible compression during the first 300 ms.

AutoStandby & AutoWakeup Mode

Off:

Disables the functions.

AutoStandby:

Enables the function.

When the function is activated and the input signal has not exceeded the defined «Threshold», the device switches to Standby mode after the predefined «Time to Standby». You can repower the amplifier at any time by selecting the «Power» button.

AutoStandby + AutoWakeup:

Enables the function.

Switching to Standby mode takes place in two stages:

1. ReadyStandby

When the signal drops below the defined «Threshold», the device switches to ReadyStandby mode after the predefined «Time to Standby».

2. Standby

The device switches to Standby mode after another two «Time to Standby» periods.

The amplifier will be repowered within less than 4 seconds as soon as an input signal is present and exceeds the defined «Threshold».

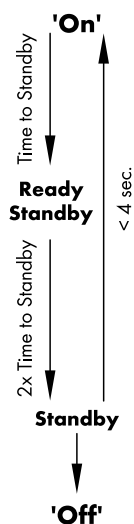

Time to Standby

Time (countdown), adjustable from 1 min. to 24 h in 1 min. increments.

Threshold

Threshold for the AutoStandby and AutoWakeup functions, adjustable from -140 dBFS to 0 dBFS in 1 dB increments.

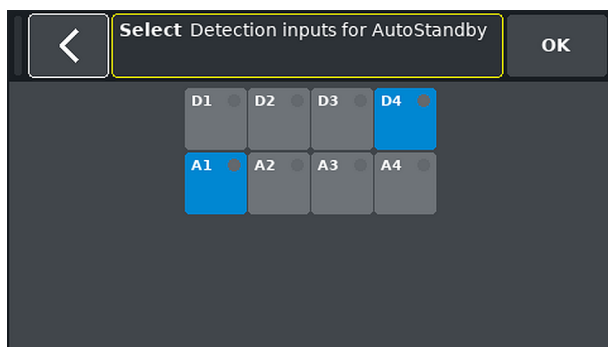

Inputs tab

The corresponding inputs, that will be monitored for incoming signals, can be specified.

6.5.6 AmpPresets

d&b amplifiers provide AmpPresets which contain all important user settings of the entire device, such as input, output and channel configurations, EQ and delay settings.

Using AmpPresets, a sound system can be operated in different configurations (e.g. "Conference", "Music" or "Emergency Call") without the need of transferring all detailed settings of the devices used.

There are three types of AmpPresets memories (slots):

- User:** Nine AmpPresets which can be accessed locally or via the d&b Remote network. These presets are used to set the complete device to a previously defined configuration for a particular application. They can be named individually.
- Alarm:** Three AmpPresets which can only be accessed via the d&b Remote network. Intended for use in alarm systems to protect the system settings against local modifications.
- Backup:** Three AmpPresets which can only be accessed via the d&b Remote network. Intended for temporary use to back up the current system settings when another AmpPreset is loaded.

Selecting «AmpPresets» opens the corresponding subscreen which provides the functions «Select», «Name», «Recall», «Store» and «Clear».

At the bottom of the screen, the last AmpPreset number loaded is indicated. If any setting has been modified since loading, «(modified)» will be added to the corresponding entry.

- Select:** Provides access to the nine (9) user preset memories (slots) for loading, saving or clearing data.
- Name:** Enables the assignment or editing of a preset name (maximum of 15 characters).
The input mask which appears allows either lower-case or upper-case characters by toggling the corresponding button («abc») on the bottom left.
 - Wrong entries can be corrected by selecting the Erase button (⌫) on the bottom right.
 - Selecting «OK» on the top right confirms the entry, closes the input mask and switches back to the AmpPresets screen.
 - Selecting the Back button (⏪) on the top left cancels any entry and switches back to the AmpPresets screen keeping the previous entry.

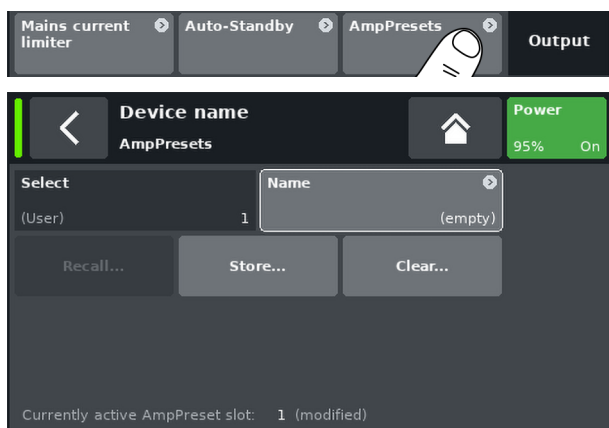

- Recall:** Recalls the settings of a stored preset.
- Store:** Stores the current amplifier settings to the selected preset memory.
- Clear:** The selected preset memory is cleared and «(empty)» is displayed on the «Name» button.

Note: Choosing one of these functions, a corresponding confirmation dialog will be issued to allow either confirmation of the selection or to cancel the action by selecting the Back button (⏪).

6.5.7 Event log

The event log stores a maximum of 10000 records. Once the maximum number of records is reached, the system starts deleting the first ones.

Device name		
Event log		
508	Error #165 cleared Input monitoring fault D1 (level 0.0dBFS, lock 0, DS data pri 0, DS da	15 Aug 2022 11:35:45.867
509	Error #166 cleared Input monitoring fault D2 (level 0.0dBFS, lock 0, DS data pri 0, DS da	15 Aug 2022 11:35:45.868
510	Error #165 appeared Input monitoring fault D1 (level -140.0dBFS, lock 1, DS data pri 0, DS	15 Aug 2022 11:36:08.192
511	Error #166 appeared Input monitoring fault D2 (level -140.0dBFS, lock 1, DS data pri 0, DS	15 Aug 2022 11:36:08.192
512	Error #165 cleared Input monitoring fault D1 (level 0.0dBFS, lock 0, DS data pri 0, DS da	15 Aug 2022 13:47:43.546
513	Error #166 cleared Input monitoring fault D2 (level 0.0dBFS, lock 0, DS data pri 0, DS da	15 Aug 2022 13:47:43.547

Channel setup access chart

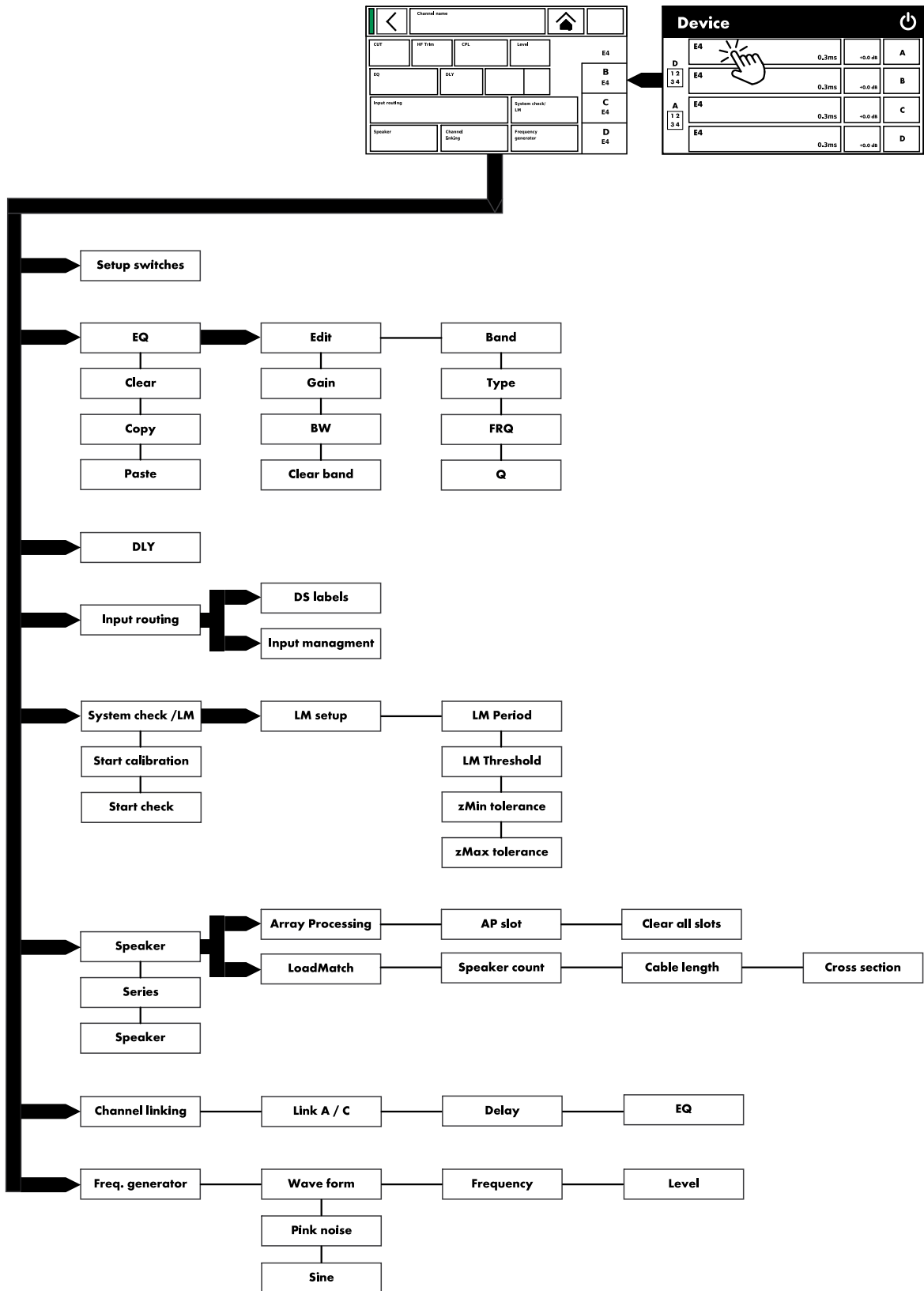

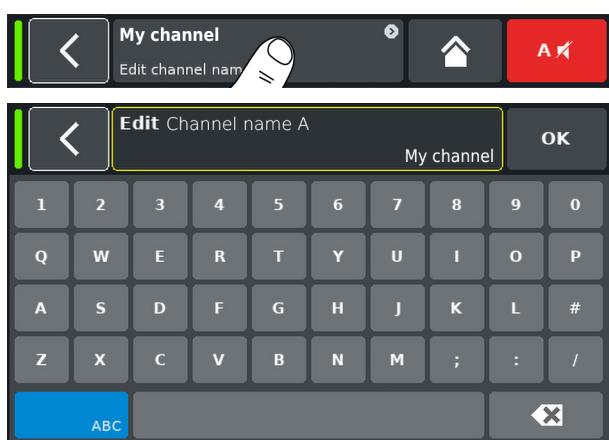
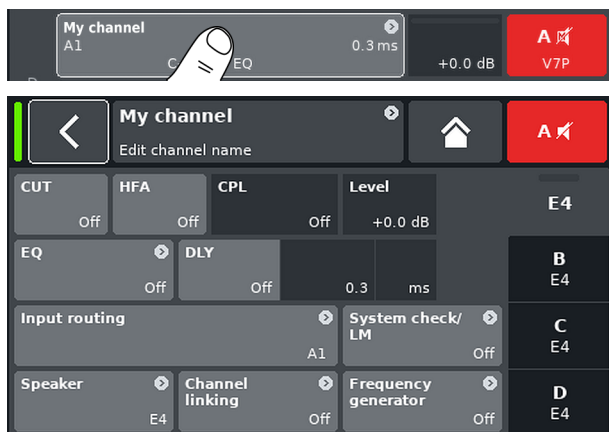

Selecting a particular channel from the Home screen opens the corresponding Channel setup screen with the respective Channel tab being active.

The Channel setup screen follows the same layout structure as described above and is split into the Header and the Data sections.

Using the tabbed structure of the Channel setup screen provides direct access to the desired function element of each channel.

In addition, the «Channel mute» button of the selected channel as well as the "ISP", "OSP", "GR", and "OVL" indicators for each channel are available. This allows you to maintain the integrity of the gain structure within the unit while setting up the user definable EQ as well as keeping an eye on the Input routing.

7.1 Channel name

Selecting the centered Information field button («Edit channel name») in the header of the Channel setup screen enables you to enter or edit the Channel name (maximum length 15 characters).

The input mask which appears allows either lower-case or upper-case characters by toggling the corresponding button («abc») on the bottom left.

Wrong entries can be corrected by tapping the Erase button (⌫) on the bottom right.

Tapping «OK» on the top right confirms the entry, closes the input mask and switches back to the channel setup screen.

Tapping the Back button (⏪) on the top left cancels any entry and switches back to the Channel setup screen keeping the previous entry.

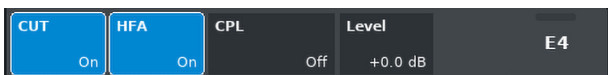

7.2 Configuration switches - Filter_1, _2, _3

The type of filters available depends on the selected loudspeaker setup.

Depending on the type of filters, these are available as function buttons or input fields.

The name of the filter is displayed on the top left of the button or field while the On/Off status or the value is displayed on the bottom right. In addition, the On/Off status is also indicated by colors.

Filter_1	Filter_2	Filter_3
Configuration of crossover frequencies for TOP/SUB, e.g. CUT, 100 Hz, Infra ... Note: CUT in LINEAR setup: <ul style="list-style-type: none"> ▪ Butterworth 2nd order (12 dB/oct.) ▪ Corner frequency: 110 Hz ▪ Amplifier gain @ 0 dB: 31 dB. 	Compensation of listening distance, e.g. HFA, HFC. HFC: Off, +1 (HFC1), +2 (HFC2). CSA: Cardioid Subwoofer Array.	CPL ⇒ Array-EQ (compensation of coupling effects) CPL range: --9 dB ... 0 dB (Off): Cut (Lo shelf) 0 dB (Off) ... ++5 dB: Boost (65 Hz, Bell)

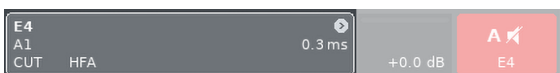

On the Home screen, the On/Off status or the set values of the Configuration switches are indicated by the entry on the Channel view button of the corresponding channel strip, as shown in the graphic opposite.

Note: A detailed description of the filters available for each loudspeaker is given in the relevant loudspeaker manuals.

A detailed description of the CSA function (Cardioid Subwoofer Array) is given in the technical information TI 330 which can be downloaded from the d&b website at www.dbaudio.com.

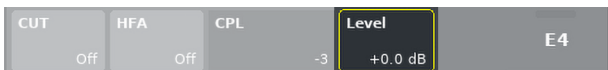

7.3 Level

Input sensitivity of the respective power amplifier channel or set of channels (depending on the output mode), adjustable within a range of -57.5 dB to +6 dB in steps of 0.5 dB.



7.4 EQ - Equalizer

Selecting «EQ» opens the equalizer subscreen of the respective channel.

The graphic opposite shows the location of the equalizer (User EQ) within the signal chain.

The equalizer provides two independent and user definable 16-band equalizers (2 x 16 minimum phase biquad IIR filters, full parametric) and is split into two layers:

- ⇒ EQ overview,
- ⇒ EQ layer/curve.

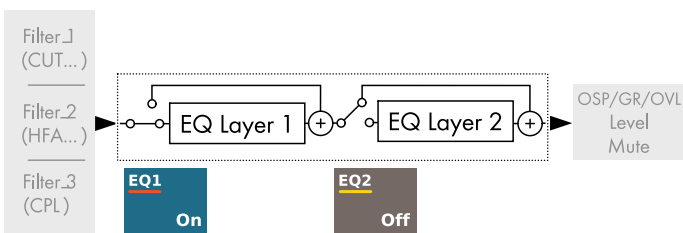

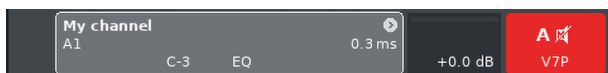
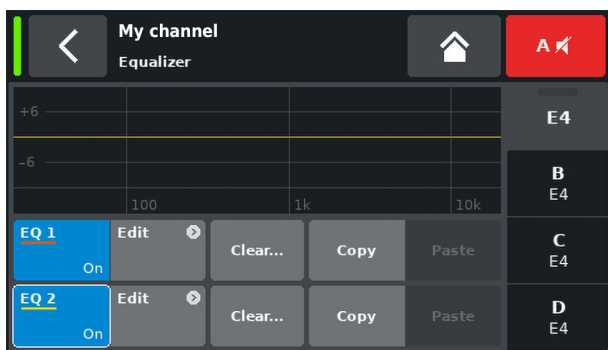

EQ overview

The upper part of the overview provides the overall frequency response of all filters while «EQ 1» is displayed in red and «EQ 2» in yellow.

Active filters are displayed by continuous lines and the curves are filled with grey color while inactive filters are displayed by dashed lines.

The bottom part of the overview provides the following functions:

EQ [n] On/Off

Master On/Off switch for the respective EQ.

On the Home screen, the On/Off status of the equalizer is indicated by the entry «EQ» on the «Channel view» button of the corresponding channel strip, as shown in the graphic opposite.

Edit

Opens the corresponding subscreen (EQ layer/curve) for editing.

Clear...

Resets all filter settings of the corresponding EQ.

To prevent accidental reset when you tap the «Clear...» button, a dialog will pop up prompting you to confirm the reset or cancel the sequence by tapping the Back button (⏪).



Copy/Paste

Allows the entire EQ settings of one channel to be copied/pasted to any other channel.

To do so, proceed as follows:

1. Select the channel EQ you want to copy.
2. Select «Copy».
 - ↳ The «Paste» button becomes accessible.
3. Select the channel to which you want to paste the EQ settings.
4. Select «Paste».

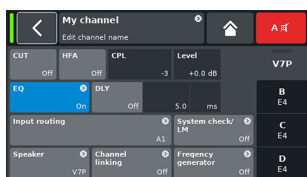

Step 1

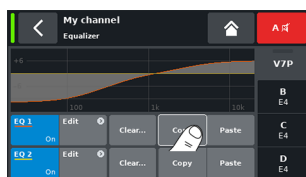

Step 2

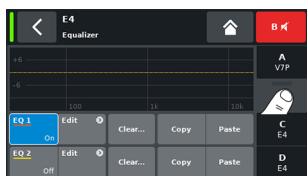

Step 3

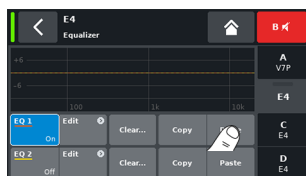

Step 4

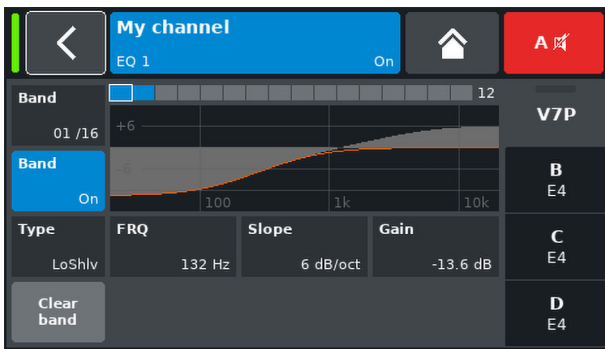

EQ layer/curve

Apart from the overall frequency response, the following functions and status indicators are provided:

Header section

EQ [n] - On/Off On/Off status of the corresponding EQ.
This field also acts as On/Off switch for the respective EQ.

Data section

Line by line from left to right:

Band selector Allows the selection of a filter band from the Filter band bar using the encoder.



Filter band bar



Displays all filter bands that are in use while the number of remaining filter bands is indicated next to the bar on the right.

Band On/Off Switches the selected filter band on or off.

Type Depending on the filter type used, 1 to 4 bands may be required for each filter.
The following table lists the available types, their corresponding parameters and the number of filter bands required for the selected type.

Type	Param. 1	Param. 2	Param. 3	Param. 4	Param. 5	No. of filters
PEQ (Parametric EQ)	FRQ	Q (and corresponding bandwidth - BW)	Gain			1
Notch	FRQ	Q (and corresponding bandwidth - BW)				1
HiShlv	FRQ	Slope	Gain			2
LoShlv	FRQ	Slope	Gain			2
Asym (Asymmetric filter)	FRQ 1	Slope 1	Gain	FRQ 2	Slope 2	4

Parameter ranges and resolutions:

Type The available filter types.

FRQ Filter frequency (center/corner frequency), adjustable from 20 Hz to 20 kHz.

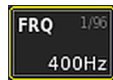

On the top right of the «Frequency/FRQ» input field, the increment is displayed as an octave value. When you tap the field for the first time, the frequency increment is set to 1/6 octave. When you tap the field again, you can toggle between 1/6 and 1/96 octave increments.

To confirm the set frequency, press the encoder.

Q Q of the filter, adjustable from 0.5 ... 25 in 10 % steps.
BW In addition, the resulting bandwidth (BW) is displayed as a value (2.0 ... 0.04 octaves) in a non-editable Information field below the Q Input field.

Slope Slope can be set to 6, 12, 18 or 24 dB/octave.

Gain Gain, adjustable from -18 dB to +12 dB in 0.2 dB steps.

Clear band Resets all settings of the selected filter band right away.

7.5 DLY - Delay

An independent signal delay is available for each channel to allow delay settings of up to 10000 ms/10 sec (3440 m/11286 ft).

DLY On/Off Switches the delay on or off without affecting the entered delay values. Set to "On" the applied value will be set right away.

Value The delay time is adjustable from 0.3 to 10000 ms in steps of 0.1 ms or a corresponding value depending on the units selected.

Unit Enables selection of the delay units, either milliseconds [ms], meters [m], feet [ft] or seconds [s]. A change in the units will be applied to all channels.

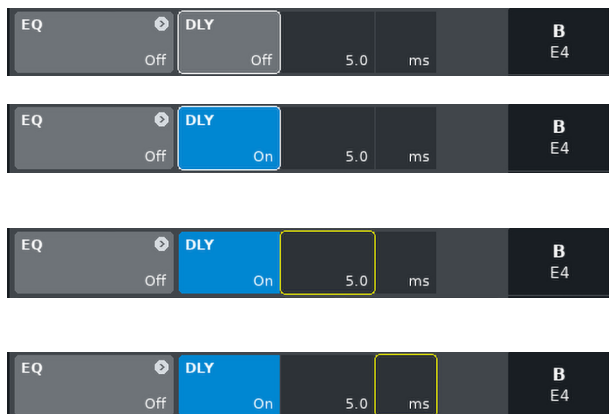

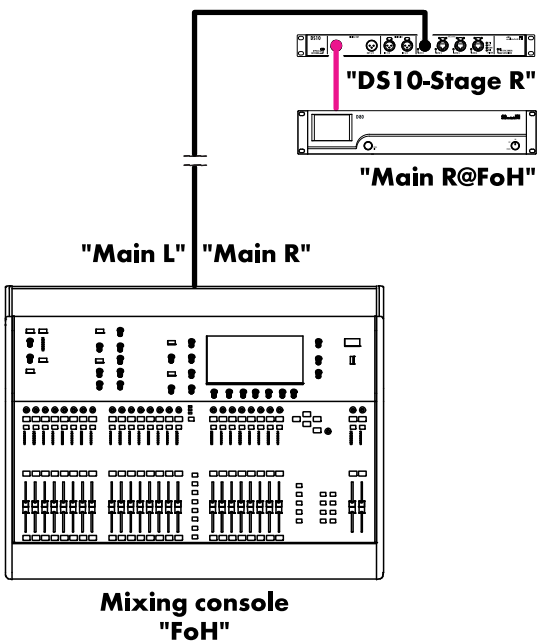
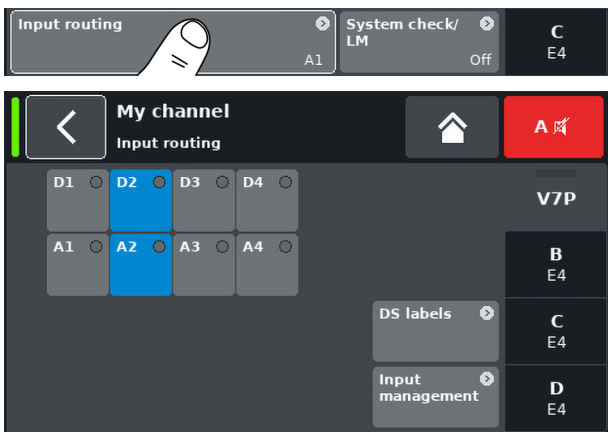

Application example

7.6 Input routing

Selecting «Input routing» opens the corresponding subscreen.

The input sources can be selected individually per amplifier channel. The Input routing screen also provides direct access to the input management screen.

DS labels

Selecting the «DS labels» button opens the «DS labels» subscreen.

In connection with d&b DS devices, meta data such as Dante channel labels and cabling information are sent via the AES3 outputs alongside the digital audio samples using the AES3 User bits.

These meta data can be read out by the amplifier and displayed on this screen. The screen is split into three columns and the following information is provided for each of the digital inputs D1 - D4:

D[n]	PRI ● SEC ●	Out [n]/[n+1]
Tx label@Tx Device	DS device name	DS rx label

- D [n]** The corresponding input.
- PRI/SEC** Indicates whether the Primary and/or Secondary Dante Audio Network is running (green - ●) or interrupted (gray - ●).
- Tx label@ Tx Device** The Dante channel that is received at this amplifier input.
- DS device name** The name of the DS device connected to this amplifier input via AES3.
- DS rx label** The configured Dante receive channel label for the DS output which is connected to this amplifier input.
- Out [n]/[n+1]** The physical DS output connected to this amplifier input.

Example

A simple example is shown in the graphic opposite. The stream labels are stated in inverted commas. The corresponding labels and their locations on the screen are listed in the table below.

D1	PRI ● SEC ●	Out 1/2
Main R@FoH	DS10 Stage R	Front - Output 1

7.7 System check/LM

7.7.1 System check

System check is a powerful and convenient tool to check the condition of a complete d&b sound reinforcement system driven by d&b amplifiers. It is preferably used in conjunction with the d&b Remote network and the R1 software.

However, for smaller systems or single cabinets, System check can also be accessed and executed locally. For both, System check and calibration, audible sine wave signals are used.

System check utilizes the amplifier's capability to measure the impedance (Z) connected to its outputs using an audible sine wave signal created by the DSP section of its controller.

Selecting «System check» opens the corresponding subscreen.

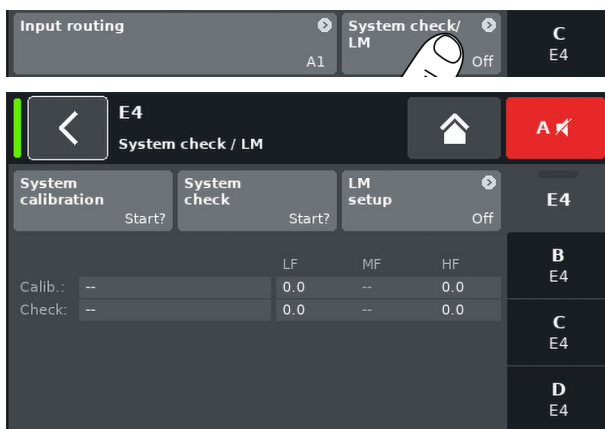

System check menu

The System check menu provides two buttons to start either a «System calibration» or a «System check» run.

In addition, a table is provided indicating the progress («Status») and the results (Z values) for both the calibration («Calib.:») and the check («Check.:») runs.

The column header of the table for the Z values changes according to the connected loudspeaker cabinet, provided the respective loudspeaker setup is loaded.

Status Brief indication of the current status of the calibration or check process. In case of an error the status is indicated in red.

LF The calibration and check results for the LF section.

LF®) The calibration and check results for the rear LF driver of an actively driven cardioid subwoofer, such as the KSL-SUB.

MF The calibration and check results for the MF section of applicable cabinets.

HF The calibration and check results for the HF section.

System check procedure

The typical procedure using System check is as follows:

1. When the system is fully set up, check and verify all connections.
2. Mute all amplifier channels.
 - ↳ The correct wiring of the system can now be tested by listening to each channel separately using an appropriate audio program and the MUTE switches - preferably controlled by R1.
3. Unmute all channels, if required.
4. Execute a **System calibration**.
 - ↳ The calibration process identifies the actual load impedances for each channel by playing different calibration noises. The result will be stored as a reference and used to calculate the upper and lower limits for the tolerance band.

To verify the correct connection of cabinets and amplifiers, the calibration result can be compared with the typical impedance values for d&b loudspeakers.

For this purpose, please refer to the d&b R1 Help (⇒ within R1 press **F1**).

5. Run **System check**

- ↳ Executing a System check after the event will repeat the measurement and display all values that are outside of the tolerance band, indicating a possible damage to the system components.

When a system is repeatedly used in the same configuration for which a calibration file exists, the System check procedure can also be used before the show to verify the system's correct setup.

A System check will only provide valid impedance values, if the amplifier has been calibrated before the check with the load connected or if a valid calibration file has been loaded using R1.

7.7.2 Load monitoring (LM)

Features

The d&b Load monitoring function is related to the System check function and serves to identify a possible loudspeaker malfunction.

Function

The calibration process, performed from the System check menu with the system fully set up, determines the impedance for each channel and calculates the related upper and lower impedance limits.

While the system is operating, d&b Load monitoring continuously monitors the load impedance separately for both frequencies. It detects any changes in loudspeaker impedance and reports an error if the limits are exceeded. For this purpose, Load monitoring uses inaudible pilot signals which are faded in for approximately 5 seconds in user defined intervals.

NOTICE!

The resolution of Load monitoring regarding failures of single components depends on the type and the number of loudspeakers connected to each channel.

The maximum number of cabinets which can be operated in parallel by one amplifier channel in order to be able to detect a failure of a loudspeaker component is given in the d&b R1 Software help (⇒ within R1 press **F1**).

Load monitoring does not work if the amplifier is switched off or switched to standby mode.

Load monitoring setup

On the «System check» screen, selecting «LM setup» opens the corresponding subscreen.

The «Load monitoring setup» menu provides all relevant parameters for adjustment to the on-site requirements.

Load monitoring On/Off

Activates Load monitoring. The On/Off status is also indicated on the System check and Channel setup screens.

Once a fault has occurred, switching off Load monitoring will also reset the error and error message.

LM Period

The maximum time it takes the system to detect a loudspeaker malfunction. The intervals of the pilot signal are derived from this parameter. The time can be set in a range from 40 to 1000 sec. in 40 sec. detents.



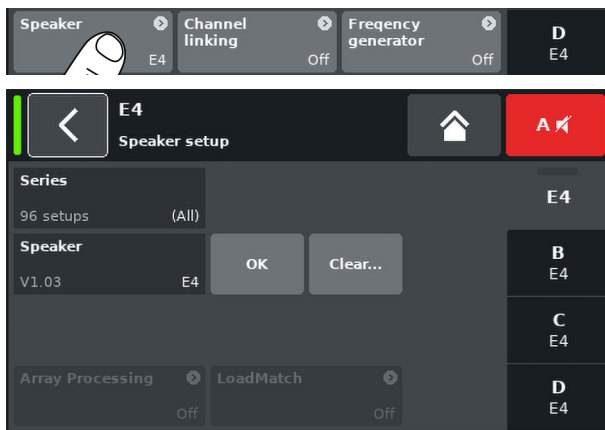

LM Threshold Large signal threshold. When the output signal exceeds this voltage level during the measurement, the tolerance limits for this particular measurement are increased in order to compensate for the reduced accuracy.

zMin tolerance Lower limit of the impedance window, which is set to -20 % by default.

zMax tolerance Upper limit of the impedance window, which is set to +30 % by default.

Dev.: Relative deviation in percent in relation to the reference values determined during calibration.

7.8 Speaker

Selecting «Speaker» opens the Speaker setup subscreen which enables the selection of loudspeaker setups for the applicable d&b loudspeakers (depending on the selected output mode).

The setups available are arranged in two blocks, «Series» and «Speaker».

Back (⏪)

The Back button provides two options:

1. The selection has not been confirmed by tapping «OK» ⇒ Cancel: Exits the subscreen and the previous configuration remains active.
2. The selection has been confirmed by tapping «OK»: Exits the subscreen.

Series

The bottom left of the «Series» Input field displays the number of setups available while the bottom right displays the actual name of the Series.

The list is in alphabetical order, the starting point, however, is the Series currently loaded.

Selecting «(All)» provides direct access to all setups available and the LINEAR setup.

Speaker

The bottom left of the «Speaker» input field displays the version of the selected loudspeaker setup while the bottom right displays the actual setup name.

The loudspeaker list is either in numerical or alphabetical order depending on the selected series.

When «(All)» is selected in the «Series» field, the list starts with the numeric setup names followed by the remaining setup names in alphabetical order. The starting point, however, is the setup currently loaded.

OK

Selecting «OK» adjacent to the «Speaker» selection field confirms the configuration and the selected setup will be activated.

Clear...

To prevent accidental reset when you tap the «Clear...» button, a dialog will pop up prompting you to confirm the reset or cancel the sequence by tapping the Back button (⏪).



Selecting the «Clear...» button clears/resets the following loudspeaker related settings of the respective channel.

- Configuration switches (Filter_1, Filter_2, Filter_3) are reset.
- Level is set to 0 dB.
- Delay settings are reset (the selected unit will be kept).
- All EQ settings are disabled.
- Load and Input monitoring are set to off.
- The respective channel is muted and the selected setup is activated.

Array Processing

For applicable loudspeakers, the «ArrayProcessing» button becomes functional. It indicates the On/Off status of the function and provides direct access to the ArrayProcessing subscreen, which is described in ⇒ Chapter 7.8.1 "ArrayProcessing" on page 52.

Note: ArrayProcessing does not apply to all loudspeakers. When the function is not applicable, this button is not functional.

LoadMatch

For applicable loudspeakers, the «LoadMatch» button becomes functional. It indicates the On/Off status of the function and provides direct access to the LoadMatch subscreen which is described in ⇒ Chapter 7.8.2 "LoadMatch" on page 53.

Note: LoadMatch does not apply to all loudspeakers. When the function is not applicable, this button is not functional.



7.8.1 ArrayProcessing

Usually ArrayProcessing (AP) data are generated within the ArrayCalc software and transferred to the amplifiers via the d&b Remote network (OCA) using R1.

However, once the ArrayProcessing data have been transferred to an amplifier remotely, each data slot may also be accessed locally.

AP slot

Selection field for each memory slot.

Note: The first slot (1) is reserved as a bypass slot.

Below the selection field, the slot name and version are displayed together with the comment for the slot that was previously entered in ArrayCalc.

In addition, the selected slot is indicated on the respective channel strip on the «Home» screen.

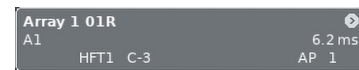

Clear all slots

Resets all slot data.

HF Trim (HFT)

As part of the ArrayProcessing feature, the HF Trim (High Frequency Trim) option allows you to trim the HF of a processed array due to changing air absorption conditions in the far field areas during a show.

The «HF Trim» option only becomes accessible when the «AP» setup of the relevant cabinets is loaded. HF Trim can be activated from the respective channel screen and can be set locally or via the d&b Remote network using R1. However, HF Trim will usually be applied for grouped cabinets within R1.

Off

No additional target distance.

+1/+2 **10% (+1)** or **20% (+2)** additional target distance for each source.

The compensation is limited to an absolute additional distance of 30 m (100 ft).

On the Home screen, the On/Off status and the setting of the HF Trim option is indicated by the entry «HFT[n]» on the «Channel view» button of the corresponding channel strip, as shown in the graphic opposite.

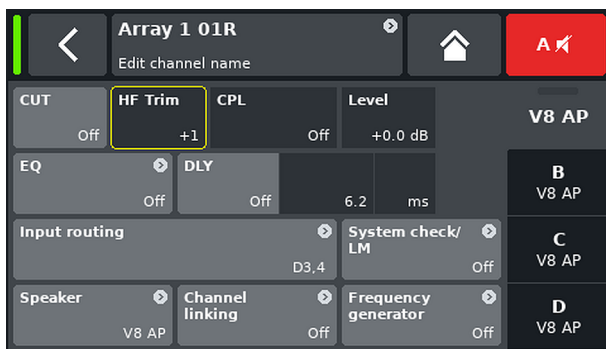

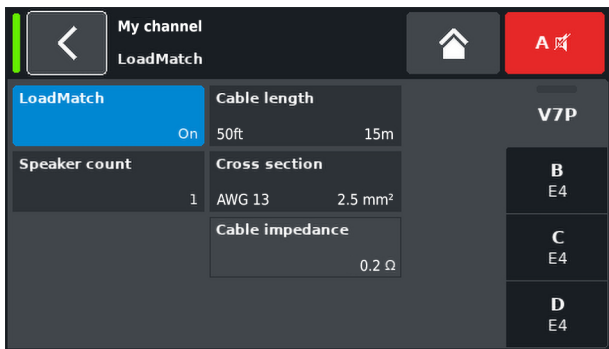

7.8.2 LoadMatch

Selecting «LoadMatch» on the Speaker setup screen opens the corresponding subscreen.

⇒ To activate LoadMatch, tap the On/Off button on the left next to the «Cable length» input field.

For applicable loudspeakers, the d&b LoadMatch function enables the amplifier to electrically compensate for the properties of the loudspeaker cable used which would otherwise change the tonal balance of the loudspeaker. The function covers a bandwidth of up to 20 kHz.

LoadMatch does not require an additional sense wire and is therefore applicable with any connector type used.

Note: Applying LoadMatch might slightly reduce available headroom as it does not (and should not) influence the limiter thresholds.

To provide optimum compensation, LoadMatch requires the entry of the following three parameters:

Cable length Length of the cable in meters in steps of 5 m.
 ⇒ The corresponding length in "ft" is displayed on the bottom left of the input field.

Speaker count Number of cabinets connected.

Cross-section Cross section in square millimeters (mm²) in steps of 0.5 mm² up to a maximum of 10.0 mm².
 ⇒ The corresponding "AWG" value is displayed on the bottom left of the input field.
 ⇒ The resulting cable impedance is shown as an ohmic value in the «Cable impedance» information field underneath.

Maximum gain reached

The message «Maximum gain reached» is displayed when the maximum compensation that the specific loudspeaker setup allows as a balance between sonic accuracy and headroom has been reached.

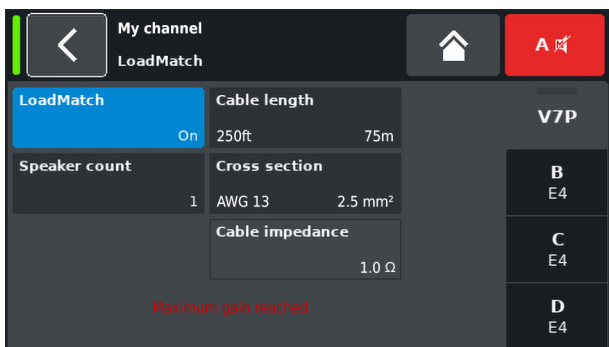

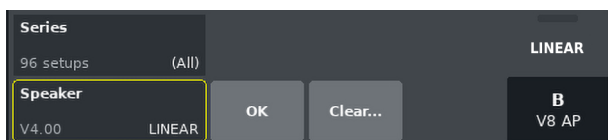

7.8.3 LINEAR setup

In addition to the loudspeaker specific setups, a LINEAR setup is also available allowing the D40 to be used as a linear power amplifier.

Note: CUT in LINEAR setup:

- Butterworth 2nd order (12 dB/oct.)
- Corner frequency: 110 Hz
- Amplifier gain @ 0 dB: 31 dB.

7.9 Channel linking

Selecting «Channel linking» opens the corresponding subscreen.

Provided the amplifier's output mode is set to Dual Channel and/or Mix TOP/SUB mode, the «Channel linking» function allows either channel EQ and/or Delay settings to be linked.

There are four direction modes:

- A ⇒ B
- A ⇒ BC
- A ⇒ BCD
- C ⇒ D

The linked functions can then be controlled from the «Channel» menu of channel A and/or C, while these functions are disabled in the «Channel» menus of channels B and D.

When choosing either «A ⇒ BC» or «A ⇒ BCD», the «Link C» function is disabled (set to «Off»).

However, when activating «Link C» while «Link A» is set as described above, the «Link A» function is disabled correspondingly.

In the «Channel» menu, this status is indicated by a horizontal eight («∞»), as shown in the graphic opposite.

The On/Off status of the link function is indicated in the respective channel menu, as shown in the graphic opposite.

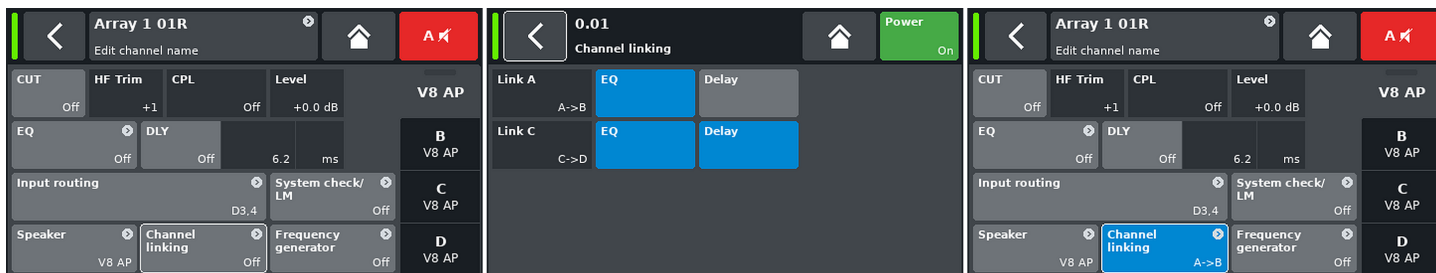
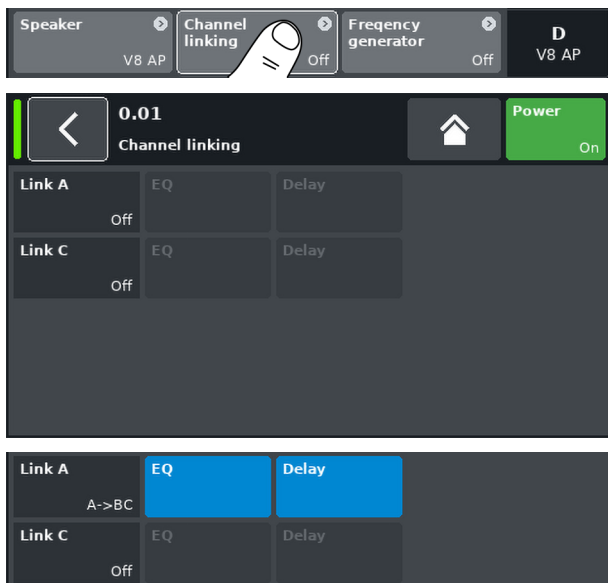

Channel linking example: EQ A ⇒ B; EQ and Delay C ⇒ D

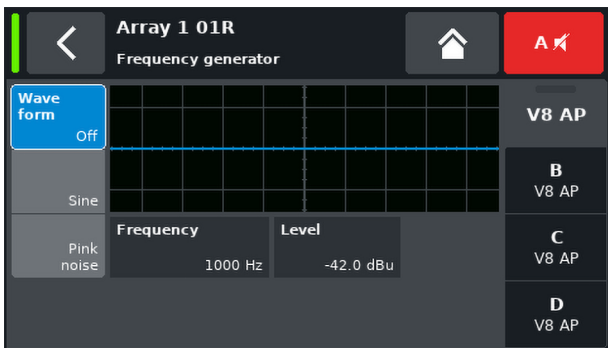
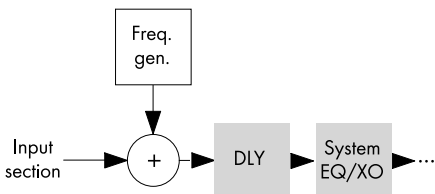

7.10 Frequency generator

Selecting «Frequency generator» opens the corresponding subscreen.

Each amplifier channel is equipped with an independent signal generator offering sine wave or pink noise signals.

The generator provides pure-spectral sine wave signals with high frequency accuracy and free of harmonics.

The generator can be used to check the connected loudspeakers or to identify room resonances, for example.

The generator is inserted in the signal path after the input section and before the actual signal processing. The test tone will sum up with any input signal present.

Note: As a precautionary measure, the frequency generator is always set to «Off» after power cycling the device.

Off The frequency generator is switched off (Bypass).

Sine/ Pink noise To turn the frequency generator on, select either «Sine» or «Pink noise», depending on the desired signal.

Frequency The frequency is adjustable from 10 Hz to 20 kHz.

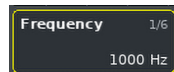

On the top right of the «Frequency» input field, the increment is displayed as an octave value. When you tap the field for the first time, the frequency increment is set to 1/6 octave. When you tap the field again, you can toggle between 1/6 and 1/96 octave increments.

⇒ To confirm the set frequency, press the encoder.

Level The level in dBu is adjustable from -57.5 dBu to +6 dBu in 0.5 dBu steps.

⇒ To confirm the set level, press the encoder.

The level value corresponds to the level at the controller signal input. The actual output voltage depends on the channel input gain, the frequency dependent gain of the selected loudspeaker setup and the EQ settings, if applicable.

⇒ To confirm the set frequency, press the encoder.

On the Home screen, the On/Off status of the generator is indicated by the entry «FG» on the Channel view button of the corresponding channel strip, as shown in the graphic opposite.

In addition, a Web Remote interface is integrated which provides direct access to the user interface of a single amplifier using a standard web browser.

Note: The user interface of the amplifier can only be accessed after connecting the amplifier to a computer via Ethernet. It is possible to connect the computer and the amplifier directly, however, this requires the IP mode DHCP+LL.

The use of a router with DHCP server is recommended for setting up the network connection. If the router also provides a wireless access point, the amplifier may also be controlled using mobile devices.

Recommended and tested browsers:

- Windows:**
 - Firefox V22.0 or higher
 - Microsoft Internet Explorer V11 or higher
 - Microsoft Edge V12 or higher
 - Google Chrome V21 or higher
 - Opera V15 or higher
- macOS:**
 - Safari V6.0 or higher
 - Firefox V22.0 or higher
 - Google Chrome V21 or higher
 - Opera V15 or higher
- iOS:**
 - iOS 6 or higher
- Android:**
 - Mobile Firefox V27.0 or higher
 - Android Browser V4.4 or higher

Remote control

To enable remote control via the Web Remote interface, proceed as follows:

1. Establish a connection between the network connector of the amplifier and the router.
 - ↳ After a while, the «Remote» tab of the amplifier screen will display the IP address the DHCP server has assigned to the device.
2. Type this address into the address field of the browser or the mobile device that is connected to the network.
 - ↳ In this case: 10.5.2.217
3. For multiple amplifiers, open one browser tab for each amplifier connected and apply the corresponding IP address.

Web Remote interface page

The Web Remote interface page is split into four tabs: the «Web Remote», «Event log», «Commands» and «Service» tabs.

Web Remote tab

The «Web Remote» tab shows the actual screen of the connected amplifier.

All screens and screen items can be accessed by simply clicking the relevant item.

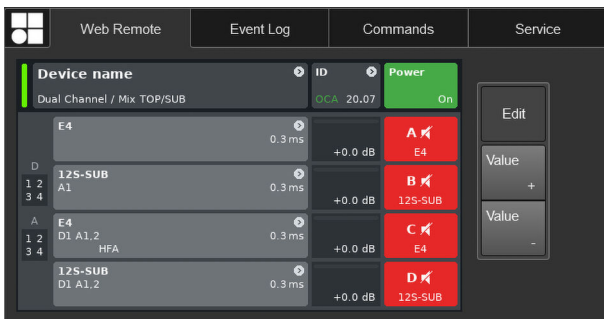

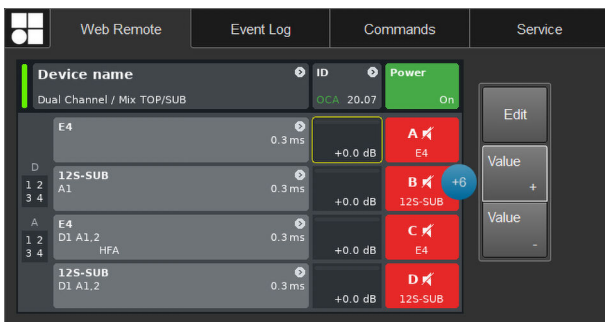
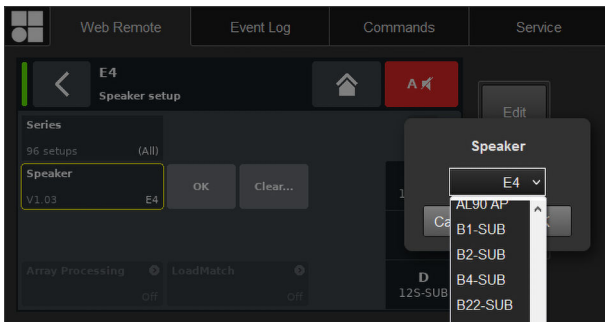
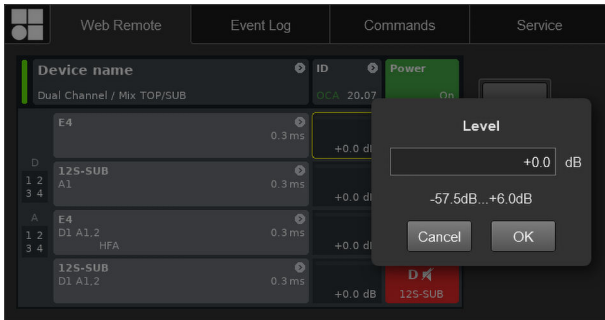

Edit dialog

To change the value of an input field such as Level, Delay time, CPL, EQ settings or Speaker setup, proceed as follows:

1. Enter the desired value or select the respective item.
 - ↳ For parameters such as «Speaker setup» or «Filter type» a drop-down list is provided to allow easy and quick access to the list items.

You can simply scroll through the list or type the corresponding character directly into the input field.
2. Confirm your entry by clicking «OK».
 - ↳ The entered value or selected list item will be applied and the «Edit» dialog will be closed.

Note: However, please note that you have to finally confirm your settings by clicking the respective «OK» button or input field again (Edit cursor changes from yellow to white ⇒ Position cursor).

Additional editing

Value +/ To change the value of an input field such as CPL, Level, Delay time, EQ settings or Speaker setup using the «Value +»
Value - «Value -» buttons, proceed as follows:

1. Select the appropriate field and change the value using the «Value +»/«Value -» buttons.
 - ↳ Every mouse click will increment the «Value +»/«Value -» by 0.5.

For example, to increase the level by 3 dB, simply click the «Value +» button six times or simply hold the mouse button until the amount of steps has been reached.

On the left, a blue counter box will appear showing the number of steps.
2. When the desired value (steps) has been reached, stop clicking or release the mouse button respectively.
 - ↳ The counter box moves to the input field previously selected.
3. As an alternative, values can also be adjusted using the wheel mouse.
 - ↳ Simply select the appropriate field and adjust the value using the wheel. This is very useful when entering major changes.

The counter field will also appear and behaves in the same manner as described above.
4. To confirm the set value, click the relevant field again or click the respective «OK» button.
5. To change/enter a device or Channel name as well as IP settings, click the relevant screen item.
 - ↳ An input mask will be displayed which allows you to enter the desired data by clicking the respective characters and/or numbers.
6. Confirm your entry by clicking the corresponding «OK» button.

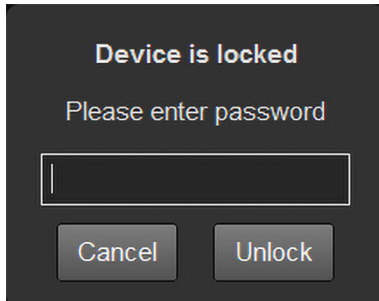

Keyboard entries

In addition, entries such as Device name or Channel name as well as IP addresses can also be entered using the keyboard. However, depending on the behavior of the browser or its settings, some characters may not be accepted or may change the focus.

Password dialog

Once the device is locked with a password, the Web Remote interface is also locked and can no longer be accessed.

A corresponding dialog will pop up to allow you to unlock the device.

Record	Date + time (UTC)	Type	Text no.	Text
501	15 Aug 2022 08:50:54,759	Error #165 cleared	-250	Input monitoring fault D1 (level 0.0dBFS, lock 0, DS data pri 0, DS data sec 0)
502	15 Aug 2022 08:50:54,759	Error #166 cleared	-251	Input monitoring fault D2 (level 0.0dBFS, lock 0, DS data pri 0, DS data sec 0)
503	15 Aug 2022 08:50:54,759	Warning #160 cleared	-803	Input fallback (A1=0, A2=0, D1=0, D2=0)
504	15 Aug 2022 08:51:14,809	Error #165 appeared	250	Input monitoring fault D1 (level -140.0dBFS, lock 1, DS data pri 0, DS data sec 0)
505	15 Aug 2022 08:51:14,809	Error #166 appeared	251	Input monitoring fault D2 (level -140.0dBFS, lock 1, DS data pri 0, DS data sec 0)
506	15 Aug 2022 08:51:14,810	Warning #160 appeared	803	Input fallback (A1=0, A2=0, D1=1, D2=1)
507	15 Aug 2022 08:51:25,798	Warning #160 cleared	-803	Input fallback (A1=0, A2=0, D1=0, D2=0)
508	15 Aug 2022 11:35:45,867	Error #165 cleared	-250	Input monitoring fault D1 (level 0.0dBFS, lock 0, DS data pri 0, DS data sec 0)
509	15 Aug 2022 11:35:45,868	Error #166 cleared	-251	Input monitoring fault D2 (level 0.0dBFS, lock 0, DS data pri 0, DS data sec 0)
510	15 Aug 2022 11:36:08,192	Error #165 appeared	250	Input monitoring fault D1 (level -140.0dBFS, lock 1, DS data pri 0, DS data sec 0)
511	15 Aug 2022 11:36:08,192	Error #166 appeared	251	Input monitoring fault D2 (level -140.0dBFS, lock 1, DS data pri 0, DS data sec 0)
512	15 Aug 2022 13:47:43,546	Error #165 cleared	-250	Input monitoring fault D1 (level 0.0dBFS, lock 0, DS data pri 0, DS data sec 0)
513	15 Aug 2022 13:47:43,547	Error #166 cleared	-251	Input monitoring fault D2 (level 0.0dBFS, lock 0, DS data pri 0, DS data sec 0)
514	17 Aug 2022 11:25:29,312	Error appeared	222	Channel 'A' LF System check Fault, 99.9(Ohm)
515	17 Aug 2022 11:25:32,235	Error appeared	222	Channel 'A' HF System check Fault, 99.9(Ohm)

Capacity: 10000 records, latest record no.: 515
Current time on device: 19 Aug 2022, 12:18:37 UTC

Event log tab

The «Event log» stores a maximum of 10000 records. Once the maximum number of records is reached, the system starts deleting the first ones ⇒ Ring buffer.

The number of records displayed depends on the size of the browser window.

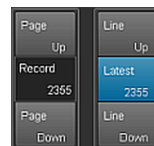

Located on the right-hand side of the record list are various Navigation buttons allowing you to scroll through the list using the «Page Up/Down» or «Line Up/Down» buttons or by directly jumping to the «Latest» record.

In addition, the editable «Record» field allows you to enter a dedicated record number. The corresponding record will be displayed at the very bottom of the record list.

Storage option

In addition, a storage option is provided which allows you to store the Event log data locally. This is mainly intended for service and/or troubleshooting purposes.

To save the Event log data locally, proceed as follows:

1. Select the «Save» button at the bottom right corner of the web browser window.
 - ↳ A corresponding dialog will pop up providing you with a drop-down list from which you can select either the number («Last [n]») of records or «All» records to be saved.
2. Choose the desired option from the drop-down list and select «Save».
 - ↳ The event log data will be downloaded and the download progress will be displayed.
 - Once the download is completed, a corresponding message will be displayed.
3. Select «Save» to store the Event log data locally.
 - ↳ Your web browser will display the corresponding dialog and the file will be saved as **Event .log** to the local download directory you have specified in the download settings of your browser.

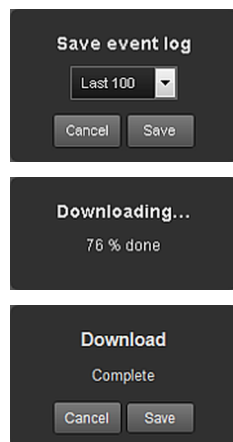

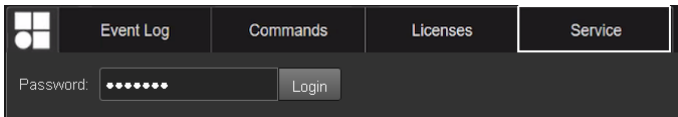

Commands tab

This functionality is intended for service purposes only.

Service tab

The «Service» tab provides a «Backup»/«Restore» function for the complete device configuration.

Note: Backups can only be restored on devices of the same type and that have a matching firmware version.

Login

To access the service functions, you first have to log in.

If the device is locked by password protection, use the corresponding password to log in. If no password protection is applied, use "dbaudio" as a password.

Backup

- ⇒ Select the «Download backup file from device» button to store the backup file (*.backup) locally.
 - ↳ Your web browser will display the corresponding dialog and the file will be saved to the local download directory you have specified in the download settings of your browser.

Restore

1. Select the «Upload backup file to device» button to upload the backup file onto the device.
 - ↳ Your web browser will display the corresponding dialog.

Once the backup file is uploaded, the «Remote ID» and «IP settings» become accessible and can be edited, if necessary by simply clicking into the corresponding input field..
2. As a final step, select the «Activate backup file on device» button to apply the backup and remote settings.

Log file collection

For service or trouble shooting purposes, a log file collection can be downloaded.

- ⇒ Select the «Download log file collection» button to store the collection file (*.logpack.) locally.
 - ↳ Your web browser will display the corresponding dialog and the file will be saved to the local download directory you have specified in the download settings of your browser.

Logout

To exit the «Service» tab functions, click the «Logout» button at the top.

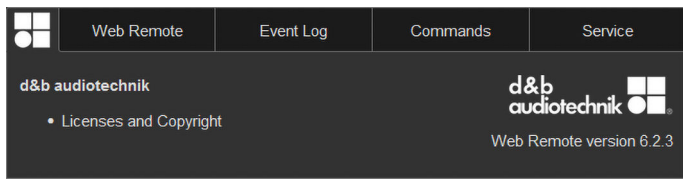

Licenses and Copyright

Selecting the d&b logo at the top left opens the «Licenses and Copyright» information page.

9.1 Power supply

The device utilizes a switch mode power supply with active Power Factor Correction (PFC) and automatic mains range selection.

The power supply is equipped with mains voltage monitoring, overvoltage and undervoltage protection as well as an inrush current limiter.

9.1.1 Active Power Factor Correction (PFC)

The active Power Factor Correction provides a clean and highly efficient sinusoidal current draw, thus providing highest performance under adverse mains conditions or when very long power cabling is necessary.

The power factor is above 0.9 for mains power consumption values of 350 W or higher.

9.1.2 Mains voltage monitoring

The mains voltage and frequency are recorded by the power supply and can be viewed on screen. Where voltages outside of this range are present, a self-resetting protective circuit responds quickly to isolate the internal "Main Power Supply" leaving only a supervisory circuit running to monitor the mains voltage. The device accepts mains voltages of up to 400 VAC_{RMS} without damage to the device in case of a missing neutral line or running phase to phase.

9.1.3 Automatic mains range selection

The automatic mains range selection enables the device to be used with any mains supply worldwide without the need for manual action. The automatic range selection is only available on plug-in but not during operation. Once in high or low range, the SMPS expects a permanent mains voltage in this range. To switch from one range to the other, the unit must be disconnected from the mains.

The power supply incorporates a "Mains Power Supply" and an "Auxiliary Power Supply".

Mains Power Supply

The Mains Power Supply feeds the power amplifiers within the following nominal mains ranges:

High range	208 - 240 VAC
Low range	100 - 127 VAC

Auxiliary Power Supply

The Auxiliary Power Supply feeds the DSP section and the device control and operates within the range from 55 VAC_{RMS} to 400 VAC_{RMS}.

Behavior with fluctuating mains voltages

With mains voltages other than the nominal voltages specified above, the device switches to the adequate mode for either "Standby" (Protection) or "Operation".

The voltage thresholds are dependent on the slope of the mains voltage change.

┌ 55 ←	75 ←	133 ←	170 ←	266 ←	400 ←
Undervoltage	Low range	Undefined	High range	Overvoltage	
Standby (Protection)	Operation	Standby (Protection)	Operation	Standby (Protection)	
55 └ ⇒	85 ⇒	140 ⇒	190 ⇒	276 ⇒	400 ⇒

Undervoltage Depending on the operating state, the device will be switched to Standby mode (Protection).
Undefined
Overvoltage

NOTICE!

In **Overvoltage** state with mains voltages above 400 V, damage to the device cannot be excluded.

In **Undervoltage** state, the Auxiliary Power Supply for the device control operates down to 55 V_{AC,RMS}.

Up to this threshold ...:

- The display remains active and the device can be operated locally.
- The LED indicators on the front panel remain active.
- Remote control via web remote or R1 is still possible without restrictions.
- Below this threshold, the device will be switched off.

9.1.4 Mains inrush current limiter

The Main Power Supply is started softly to limit inrush current. Up to two D40 may be powered up at the same time without triggering a line circuit breaker of 13-16 A (230 V) or 20 A (100-120 V) respectively.

9.1.5 Mains supply requirements

Due to the high power capability of the amplifier, properly dimensioned mains supply installation and distribution are essential.

However, the mains supply benefits from the built-in active PFC (Power Factor Correction) function of the amplifier, which causes an almost ideal (sinusoidal) current shape. Power losses of the mains supply and cables are kept to the lowest possible minimum.

Due to its automatic mains voltage selection, the amplifier can be fed from all usual mains voltages within the rated ranges as stated in ⇒ Chapter 9.1.3 "Automatic mains range selection" on page 61. Within these ranges, the mains voltage does not affect average output power figures due to the built-in regulated power supply. However, the dynamic character of common audio signals may cause short-time power peaks being twice as high as the average values. The resulting higher current draw causes an increased voltage drop on the mains line which may reduce the available output power if it gets too high.

To ensure safe and stable operation, observe the following recommendations and specifications:

- Operate a single amplifier on a 13 A circuit breaker at 208 to 240 V (high range) or on a 20 A circuit breaker at 100 to 127 V (low range).
- Operate the amplifier at a high-range supply (208 to 240 V), if possible. A low-range supply (100 to 127 V) requires a cable cross section that is 4 times higher to achieve comparable power performance.
- When three amplifiers are operated with a three-phase (120°) mains supply, the current on the N (neutral) conductor can be minimized by matching loads and signals between the three devices.
- Keep the supply line as short as possible and its cross section as high as possible, especially when operating the device at 100 to 127 V. Voltage drop at full load (20/13 A at 115/230 V) should not exceed 5 %. For reference specifications, refer to the following table.

Maximum cable lengths for 5 % voltage drop at 3600 W mains power draw				
Cable cross section	100 V	120 V	208 V	230 V
1.3 mm ² - AWG 16	Not permitted	Not permitted	21 m/69 ft	25 m/82 ft
1.5 mm ²	Not permitted	Not permitted	24 m/79 ft	29 m/95 ft
2.1 mm ² - AWG 14	Not permitted	Not permitted	33 m/108 ft	40 m/131 ft
2.5 mm ²	Not permitted	Not permitted	40 m/131 ft	49 m/161 ft
3.3 mm ² - AWG 12	12 m/39.5 ft	18 m/60 ft	53 m/174 ft	64 m/210 ft
4.0 mm ²	15 m/50 ft	21 m/69 ft	63 m/206.5 ft	78 m/256 ft
5.3 mm ² - AWG 10	19 m/62 ft	28 m/92 ft	83 m/272 ft	102 m/334.5 ft
6.0 mm ²	22 m/72 ft	32 m/105 ft	95 m/312 ft	116 m/380.5 ft
8.4 mm ² - AWG 8	31 m/101 ft	44 m/144 ft	133 m/436 ft	162 m/531.5 ft

9.1.6 Generator operation/UPS requirements

To operate the amplifier using a mains generator or uninterruptible power supply (UPS), observe the following:

- With the D40 amplifier the apparent power figure (VA value) is about the same as the effective power figure (W value).
- Use a generator or UPS that can deliver the maximum power required by the entire system. Assume a short time power draw of 3 kVA per D40. This is particularly important when using a UPS without dedicated short-time overload capability.
- Run the generator or UPS at 220 to 240 V, if available. 50 or 60 Hz is not an issue.

9.2 Power amplifiers

The power amplifiers fitted to the D40 utilize Class D technology similar to a switch mode power supply. Compared to the known linear amplifier concept (Class A, AB, G or H), Class D power amplifiers produce less heat and allow for a compact and light-weight design.

While supplying very high maximum output swing, they maintain high efficiency with any kind of signal and load and run as cool as possible. Channels share the same power supply and are thermally coupled to provide even higher average power figures when unevenly loaded. TOP/SUB setups and active cardioid subwoofers are cases of typical use. A sophisticated circuit design decreases the impact of the load on the amplifier performance and enables a well defined sound reproduction. A comprehensive set of protection features individually prevents each channel from overload and/or damage/defect. Channels that are not affected will continue to operate, if safely possible.

9.3 Cooling fans

Two temperature and level controlled fans are incorporated for cooling the internal components, which allows greater cooling during louder program material. The fan speed is consequently reduced during quieter passages preventing background noise interference. If the unit heats up a «Temp. Warning» is issued and the fans will give full cooling power permanently.

10.1 Service



CAUTION!

Potential risk of explosion.

The device incorporates a lithium battery which may cause danger of explosion if not replaced correctly.

Refer replacement only to qualified service personnel authorized by d&b audiotechnik.

Do not open the device. No user serviceable parts inside. In case of any damage do not operate the device under any circumstances.

Refer servicing only to qualified service personnel authorized by d&b audiotechnik. In particular if:

- objects or liquids have entered the device.
- the device does not operate normally.
- the device was dropped or the housing is damaged.

10.2 Maintenance and care

During normal operation, the amplifier provides maintenance-free service.

Due to the cooling concept, no dust filters are required. As a result, filter exchange or cleaning the filters is not necessary.

10.2.1 Touchscreen cleaning

After a certain period of time, the touchscreen may require cleaning.

For this purpose, proceed as follows:

- Use a soft cloth only.
- Do not use any solvent cleaners.

To remove very heavy dirt from the panel, it may be helpful to use a special cleaning spray for TFT screens. In this case, proceed as follows:

1. Spray on the soft cloth before wiping the screen.
 - ↳ Never apply/spray directly on the screen as the liquid could penetrate the device.
2. Wipe the screen with moderate pressure.

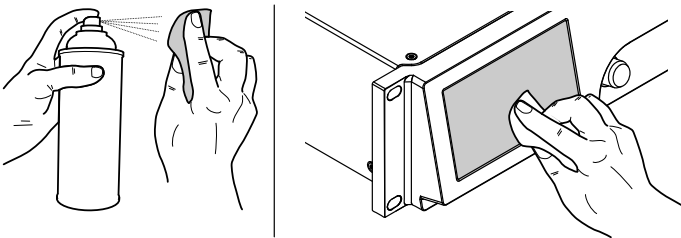

10.2.2 Touchscreen calibration

Indication

Due to mechanical impact or the aging process of the touchscreen, its calibration references may change.

An indication is that when you tap a specific button and the adjacent button is activated instead or when a specific button does no longer work.

In such cases, the touchscreen should be recalibrated.

Calibration

To calibrate the touchscreen proceed as follows:

1. From the «Home» screen go to «Device» ⇒ «More» ⇒ «Preferences» ⇒ «Display».
2. On the bottom left, select «Touchscreen calibration».
 - ↳ The calibration menu will be issued, guiding you through the calibration procedure.

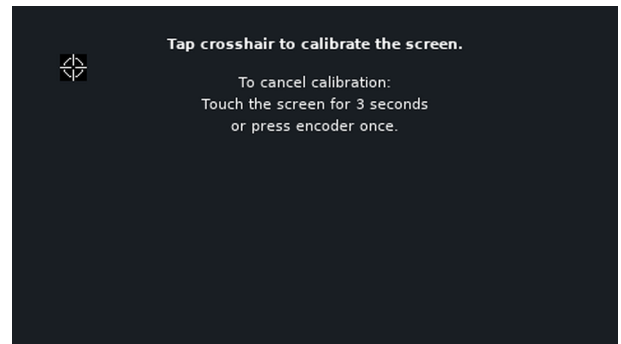
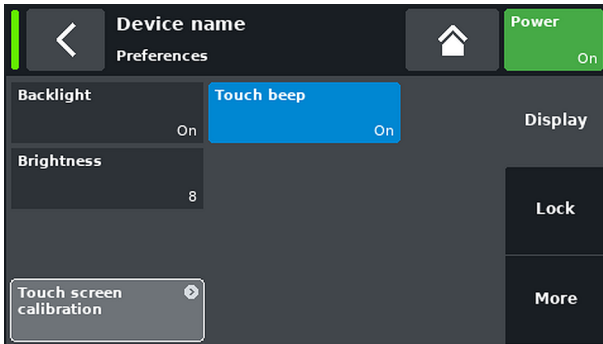

3. Follow the on screen instructions respectively.

10.3 Possible error messages

The following table lists possible error messages appearing on the display ordered by the error ID.

ID	Display text	Eventlog text	Description	Location	Possible reasons
11	System error 128	System error 128 (I2C, IC 0x%02X, Pos %d)	Internal I2C comm. error	DS	Internal hardware or software fault
15	Unknown device type	Unknown device type %d	Unknown device type		Wrong or missing serial No.
16	Invalid device ident	Invalid device ident %d	Invalid hardware configuration	ADDAC, Amp, SMPS	Missing or wrong module identification
19	Invalid display ident	Invalid display board ident %d	Invalid DISPLAY identification	Display	Missing or wrong DISPLAY identification
20	Program error %u	Program error %d, %d, %d, %d	Program error	DSP	Various
21	Invalid DSP Data	Invalid DSP database (Position %d, Error %d)	Invalid DSP data	DSP	Software error
25	Program error %u	Program error %d: AWL error %d in AWL %d, line %d	Program error	DSP	Various
27	SMPS in bootloader	SMPS stuck in bootloader	Software missing on SMPS controller	SMPS	Firmware update failed or flash corruption, retry update
28	SMPS comm. error	SMPS communication error (error %04X)	SMPS comm. error Missing keepalive for 1 sec	SMPS	SMPS fault or internal communication disturbed
30	SMPS temp. error %d °C	SMPS temperature error %3d °C (power %uW)	Critical SMPS temperature	SMPS	Insufficient cooling
32-34	SMPS supply error	SMPS supply error XXXVXXX (%5dmV, err %04X)	Supply voltage out of range	SMPS	Fluctuating mains voltage, SMPS fault
35	SMPS ZK1 overvoltage	SMPS supply error Zk1 overvoltage (Zk1 %3dV, %04X)	Supply voltage out of range	SMPS	
36	Mains surge	Mains surge detected (Zk1 peak %3dV, Mains peak %3dV)	SMPS surge restart	SMPS	Rapid surge on mains voltage
37	Mains undefined range	Mains undefined range (avg %3dV, err %04X)	Mains voltage out of range at startup	SMPS	Refer to:
38	SMPS overcurrent	SMPS overcurrent (i-peak %3.1dA, avg %3dV, err %04X)	SMPS overcurrent	SMPS	Refer to:
39	Mains overvoltage	Mains overvoltage (avg %3dV, peak %3dV, err %04X)	Mains voltage too high for current range	SMPS	Refer to:
40	Mains undervoltage	Mains undervoltage (avg %3dV, peak %3dV, err %04X)	Mains voltage too low for current range	SMPS	Refer to:
41	Mains frequency fault	Mains frequency fault (%3d Hz, err %04X)	Mains frequency out of range	SMPS	External

ID	Display text	Eventlog text	Description	Location	Possible reasons
43	SMPS restart error	SMPS error: too many restarts (restart count %d)	SMPS restart fault	SMPS	An error prevents startup or SMPS fault
44	SMPS rail "Eco" erro	SMPS rail "Eco" error (i-peak %3.1dA, rail %3dV, err %04X)	SMPS rail "Eco" error	SMPS	Power consumption too high in "Eco"
45	SMPS rail startup error	SMPS rail startup error (i-peak %3.1dA, rail %3dV, err %04X)	SMPS rail error at startup	SMPS	Power consumption too high during startup phase
46	SMPS rail run error	SMPS rail run error (i-peak %3.1dA, rail %3dV, err %04X)	SMPS rail error	SMPS	Power Consumption too high in normal mode.
47	SMPS controller reset	SMPS controller unexpectedly reset (reason: %04X)	SMPS controller unexpectedly reset	SMPS	Various
50	Invalid device para	Channel '%c': invalid device parameters (device ident %d)	Invalid device parameters	DSP	Software error or wrong device type detected
51	Invalid DSP prog %u	Channel '%c' : invalid DSP program %d	DSP program invalid	DSP	Software error
52	DSP boot error	Channel '%c': DSP boot error (DSP program %d)	DSP boot error	DSP	DSP or software error
53	DSP systick stall	DSP '%c' system ticker stalled	DSP Systick stalled	DSP	DSP or software error
58	DSP comm. error	Channel '%c': DSP communication error	DSP comm. error	DSP	DSP fault or software error
59	Invalid setup data	Channel '%c': invalid speaker setup (speaker id %d, no. %d, err %d)	DSP invalid setup data	DSP	Software error
61	Invalid AP slot %d	Channel '%c': invalid AP slot %d (file version %d)	Invalid ArrayProcessing data		Software error
78	Full amp. error.	Full amp. error (SMPA AB %04X, SMPA CD %04X)	Full amp. error	SMPA	All channels show an error
79	Amp. in bootloader	Channel '%c' stuck in bootloader	Amp. in bootloader	SMPA	Firmware update failed or flash corruption, Retry update
80	Amp. comm. error	Channel '%c' communication error (error %04X)	Amp. comm. error No keealive for 1 sec	SMPA	Communication disturbed or SMPA fault
82	Temperature error %d °C	Channel '%c' temperature error %d °C (power %uW)	Critical amp. channel temperature	SMPA	Insufficient cooling
83-87	Supply fault	Channel '%c' supply fault XXXX (err %04X, %5dmV)	Aux. supply voltage out of range	SMPA	Hardware fault
88	Overcurrent	Channel '%c' output overcurrent (CL counter %3.1ukCnt, power %uW, temp. %d °C)	Overcurrent, Overvoltage on output	SMPA	Short curcuit on output

ID	Display text	Eventlog text	Description	Location	Possible reasons
89	DC on output	Channel '%c' DC error	DC on output	SMPA	Hardware fault
90	HF on output	Channel '%c' HF error	HF on output	SMPA	Software error
91	Ext. amp. error	Channel '%c' ext. amp. reported an error (ext. err %04X, err %04X)	Ext. Amp. controller in protection	SMPA	
92	Ext. amp. no comm.	Channel '%c' ext. amp. no communication (ext. err %04X, err %04X)	Ext. amp. no comm.	SMPA	
93	Sudden overtemp.	Channel '%c' sudden temporary overtemperature (i-peak %3.1dA)	Sudden temporary overtemperature on channel	SMPA	Current peak on output
94	Overtemperature %d °C	Channel '%c' overtemperature %d °C (power %uW)	Channel mute due to overtemperatur	SMPA	Insufficient cooling
95	Clock fault	Channel '%c' clock fault (%3.1ukHz, power %uW)	Clock fault	SMPA	SMPA fault
96	Supply fault	Channel '%c' supply fault 220V (err %04X, %5dmV)	Supply fault	SMPA	Hardware fault, short on output, SMPA, SMPS fault
97	Rail loss mute	Channel '%c' muted due to rail loss (err %04X, %3.1dV)	Rail unexpectedly low	SMPA	Mains voltage loss
98	Mains loss mute	Channel '%c' muted due to mains loss (err %04X, avg. %3dV)	Mains unexpectedly not OK	SMPA	Mains voltage loss
99	Temp. warning %d °C	Channel '%c' temperature warning %d °C (power %uW)	High channel temperature warning	SMPA	Insufficient cooling
100	SMPS temp. warning %d °C	SMPS temperature warning %3d °C (power %uW)	High SMPS temperature warning	SMPS	Insufficient cooling
124	OCA remote error	OCA remote error %u	OCA remote error		
150	Speaker imp. fault		Load Monitoring impedance error		Speaker or cable fault
160	Input fallback	Input fallback (A1=%d, A2=%d, D1=%d, D2=%d)	Input Fallback		Input Fallback was activated
161-164	Input monitoring fault	Input monitoring fault AX (level %4.1ddBu, threshold %4.1ddBu)	Input Monitoring Fault		Cabling
165-168	Input monitoring fault	Input monitoring fault DX (level %4.1ddBFS, lock %d, DS data pri %d, DS data sec %d)	Input Monitoring Fault		Cabling, routing, unlocked



11.1 Declaration of Conformity

This declaration applies to:

d&b Z2850 D40 Amplifier

by d&b audiotechnik GmbH & Co. KG.

All product variants are included, provided they correspond to the original technical version and have not been subject to any later design or electromechanical modifications.

We herewith declare that said products are in conformity with the provisions of the respective directives including all applicable amendments.

Detailed and applicable declarations are available on request and can be ordered from d&b or downloaded from the d&b website at www.dbaudio.com.



11.2 WEEE Declaration (Disposal)

Electrical and electronic equipment must be disposed of separately from normal waste at the end of its operational lifetime.

Please dispose of this product according to the respective national regulations or contractual agreements. If there are any further questions concerning the disposal of this product, please contact d&b audiotechnik.

WEEE-Reg. -Nr. DE: 13421928

11.3 Licenses and Copyright

A list of the components and a full-text version of all licenses and copyrights can be accessed using the amplifier's Web Remote interface.

⇒ Selecting the d&b logo at the top left of the «Web Remote» interface page allows access to the «Licenses and Copyright» information page.

This page provides an overview of the open source software used in this product. As required by the GPL and LGPL licenses, we will send you a copy of the used source code on request. If you would like to obtain a copy, please contact us by mail to:

software.support@dbaudio.com

