

XS

4S/5S
Manual 1.5 en

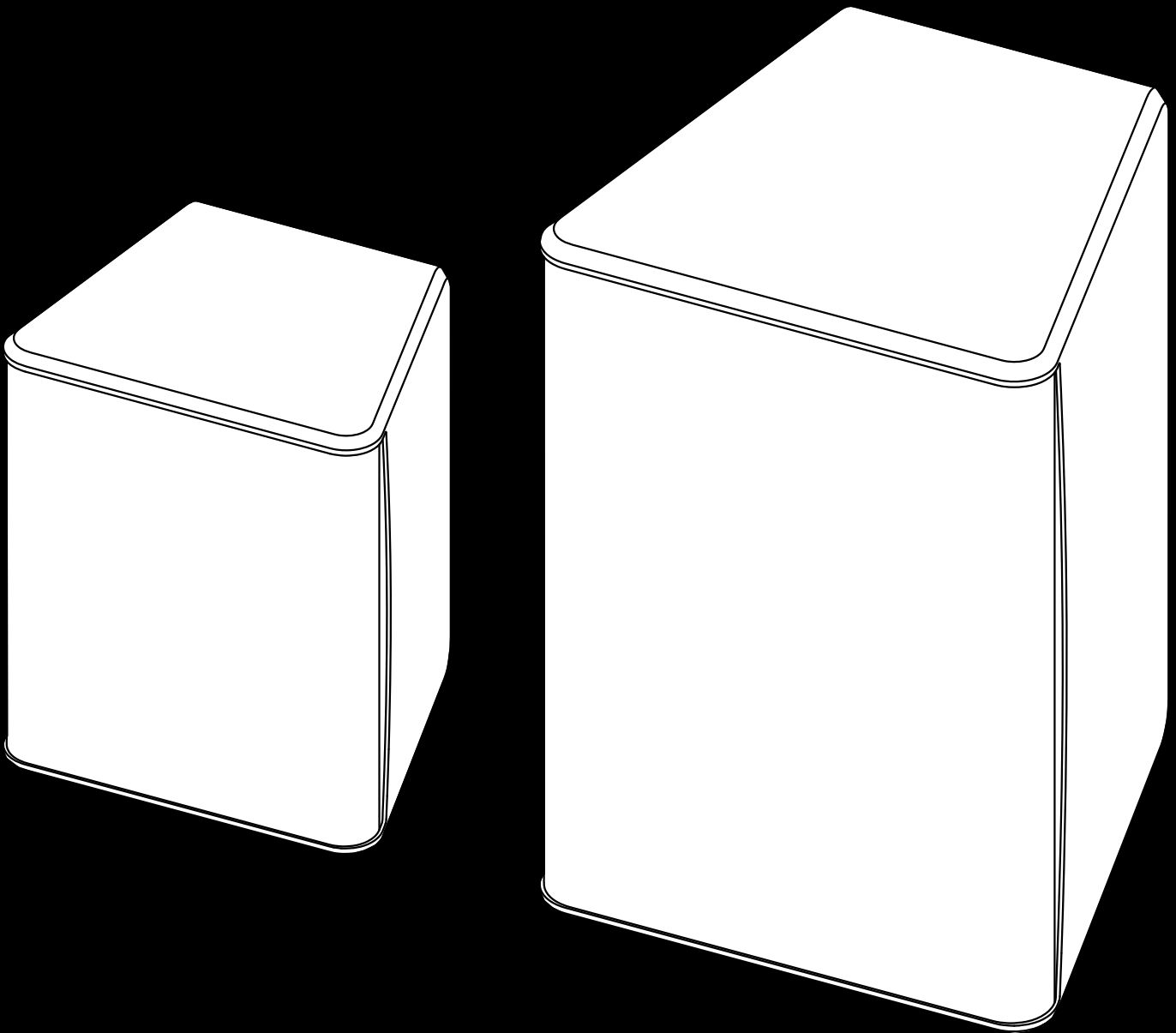

General information

4S/5S Manual

Version: 1.5 en, 10/2021, D2607.EN .01

Copyright © 2021 by d&b audiotechnik GmbH & Co. KG; all rights reserved.

Keep this document with the product or in a safe place so that it is available for future reference.

When reselling this product, hand over this document to the new owner.

d&b audiotechnik GmbH & Co. KG
Eugen-Adolff-Str. 134, D-71522 Backnang, Germany
T +49-7191-9669-0, F +49-7191-95 00 00
docadmin@dbaudio.com, www.dbaudio.com

1	Safety precautions	4
2	4S/5S loudspeaker	5
2.1	Product description.....	5
2.2	Connections.....	6
2.3	Operation.....	8
2.3.1	Controller settings.....	8
2.4	Dispersion characteristics.....	9
2.5	Technical specifications.....	9
3	Manufacturer's declarations	11
3.1	Conformity of loudspeakers.....	11
3.2	WEEE Declaration (Disposal).....	11

Potential risk of personal injury

Never stand in the immediate vicinity of loudspeakers driven at a high level. Professional loudspeaker systems are capable of causing a sound pressure level detrimental to human health. Seemingly non-critical sound levels (from approx. 95 dB SPL) can cause hearing damage if people are exposed to it over a long period.

In order to prevent accidents when deploying loudspeakers on the ground or when flown, please take note of the following:

- When setting up the loudspeakers or loudspeaker stands, make sure they are standing on a firm surface. If you place several systems on top of one another, use straps to secure them against movement.
- Only use accessories which have been tested and approved by d&b for assembly and mobile deployment. Pay attention to the correct application and maximum load capacity of the accessories as detailed in our specific "Mounting instructions" or in our "Flying system and Rigging manuals".
- Ensure that all additional hardware, fixings and fasteners used for installation or mobile deployment are of an appropriate size and load safety factor. Pay attention to the manufacturers' instructions and to the relevant safety guidelines.
- Regularly check the loudspeaker housings and accessories for visible signs of wear and tear, and replace them when necessary.
- Regularly check all load bearing bolts in the mounting devices.

Potential risk of material damage

Loudspeakers produce a static magnetic field even if they are not connected or are not in use. Therefore make sure when erecting and transporting loudspeakers that they are nowhere near equipment and objects which may be impaired or damaged by an external magnetic field. Generally speaking, a distance of 0.5 m (1.5 ft) from magnetic data carriers (floppy disks, audio and video tapes, bank cards, etc.) is sufficient; a distance of more than 1 m (3 ft) may be necessary with computer and video monitors.

2 4S/5S loudspeaker

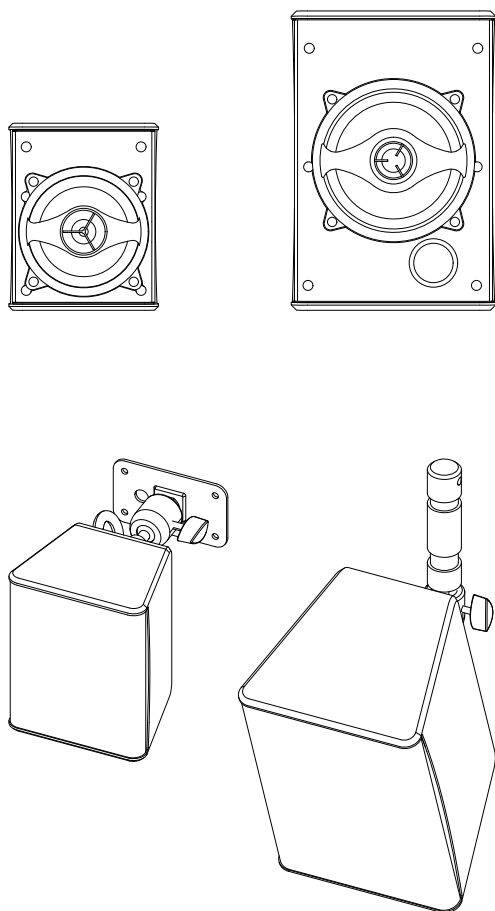

Fig. 1: 4S/5S loudspeaker

Rigging examples:

4S with Z5422 Wall mount S,

5S with Z5029 TV spigot

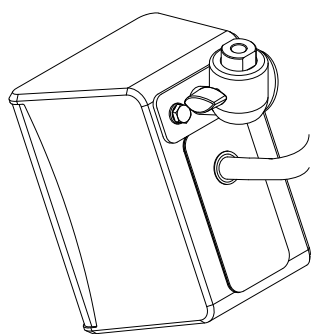

Fig. 2: Example outdoor use of the 4S cabinet

2.1 Product description

The 4S and 5S cabinets are light-weight 2-way passive loudspeakers using coaxially mounted, wide dispersion dome tweeters. The coaxial design offers a symmetrical dispersion pattern in the horizontal and vertical plane while the cabinets may be mounted in either attitude.

The 4S employs a 4" neodymium LF driver in an ultra-compact, sealed enclosure. Its frequency response extends from 130 Hz to 20 kHz.

The 5S comprises a 5" ferrite LF driver in a bass-reflex enclosure covering the range from 80 Hz to 20 kHz.

Both systems can be used stand-alone or supplemented by different subwoofers of the xS-Series.

The enclosures are injection molded with an impact resistant black paint finish. The fronts of the loudspeaker cabinets are protected by a rigid metal grill backed by an acoustically transparent foam.

The 4S and 5S rear panels incorporate two M8 threaded inserts to accept the Z5422 Wall mount S. Using the M10 socket of its ball joint adapter, the loudspeakers can be connected to different d&b mounting accessories such as:

- Z5029 TV spigot,
- Z5034 Stand adapter,
- E6532 Super Clamp,
- Z5035 M10 to 3/8" adapter.

Intended use

Both cabinets are weather protected and suitable for outdoor use. For unprotected outdoor operation the screw terminals must be used for connection and the cover panels to hide the connector panel (IP34, vertical aiming from +15° to -45°). A detailed description of how to apply the fixed cable connection is given in the following section (⇒ Chapter 2.2 "Connections" on page 6).

For this purpose the 4S cabinet must be installed with the M8 inserts located at the top of the cabinet's rear panel.

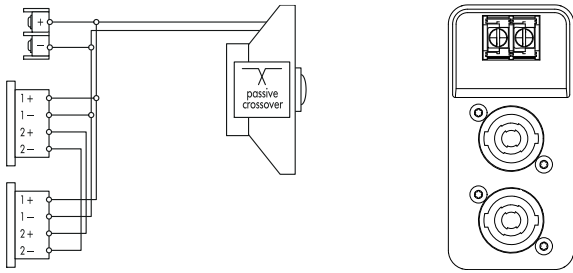

Fig. 3: Connector wiring

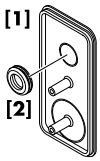

Fig. 4: Cover plate and rubber grommet



Fig. 5: Installing the fixed cable connection

2.2 Connections

The cabinets are fitted with a pair of NL4 connectors and a two pole screw terminal block (ST - cross-section up to 4 mm²/ AWG 11). All four pins of both NLT4 connectors are wired in parallel. The cabinets use the pin assignments 1+/1-. Pins 2+/2- are designated to active subwoofers.

Pin equivalents of the applicable connector options are listed in the table below.

NL4	1+	1-	2+	2-
ST	+	-	n.a.	n.a.

Fixed cable connection

The 4S and 5S loudspeakers are each supplied with a cover plate [1] and a rubber grommet feed through [2]. For indoor operation, these items can be used to hide the connector panel, if required. For unprotected outdoor operation, the connector panel must be covered, i.e. both items must be used to achieve an IP degree of protection of IP34.

To install the fixed cable connection, proceed as follows:

1. Prepare the rubber grommet and the connection cable.
2. Remove the knockout opening in the cover plate and attach the rubber grommet correspondingly.
3. Insert the connection cable through the rubber grommet and connect the cable wires to the screw terminal.
⇒ Observe the correct polarity!
4. Push the cover plate towards the connector panel until the two spigots of the cover plate are in line with the center holes of the two NL4 connectors.
5. Finally push the cover plate towards the cabinet until it completely fits into the recess of the connector panel.

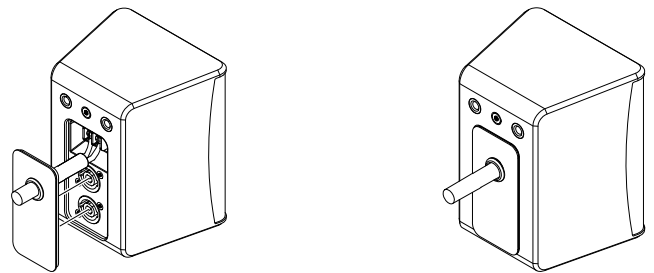

WR option (Weather Resistance)

NOTICE!

The WR option enables operation of loudspeakers in changing ambient conditions, however it is not intended to enable permanent, unprotected operation of loudspeakers outdoors.

- Provide an additional cover over the loudspeakers.
- Aim the cabinets either horizontally or with a downward tilt.

A number of d&b loudspeakers are available in special options suitable for different types of installed applications and environmental conditions. The following options are available:

- Sea water resistant (SWR): This option is suitable for outdoor use, especially in wet and acid or salty environments.

WR cabinets are equipped with a recessed connector panel including a Faston type connector (2 x 6.3 mm, female). A cover plate which accepts single or dual PG cable glands (Type PG13.5 for cable diameters from 6 - 12 mm) is enclosed.

To install the connection cable, please proceed as follows:

Tools required: Screw driver (#T20).

Note: Observe the correct polarity of the cable: Brown (+) / Blue (-).

1. Insert the connection cable through the PG screwing and connect the male connector to the female connector.
2. Push the cover plate towards the connector panel until it fits into place.
3. Fix the cover plate to the connector panel using the four countersunk screws.

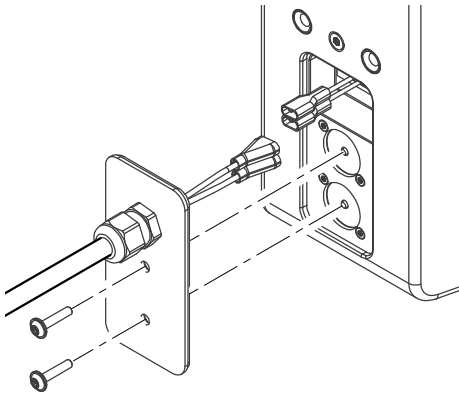

Fig. 6: Faston type connector, male single PG

2.3 Operation

NOTICE!

Only operate d&b loudspeakers with a correctly configured d&b amplifier, otherwise there is a risk of damaging the loudspeaker components.

Applicable d&b amplifiers:

10D/30D/D6/D12/D20/D80.

Application	Setup	Cabinets per channel
4S	4S	4
5S	5S	4

Within applicable d&b amplifiers, the controller setups are available in Dual Channel or Mix TOP/SUB mode.

2.3.1 Controller settings

For acoustic adjustment the functions CUT, HFA and CPL can be selected.

CUT circuit

Set to CUT, the cabinet low frequency level is reduced. The cabinets are now configured for use with d&b active subwoofers.

HFA circuit

In HFA mode (High Frequency Attenuation), the HF response of the system is rolled off. HFA provides a natural, balanced frequency response when a unit is placed close to listeners in near field or delay use.

High Frequency Attenuation begins gradually at 1 kHz, dropping by approximately 3 dB at 10 kHz. This roll off mimics the decline in frequency response experienced when listening to a system from a distance in a typically reverberant room or auditorium.

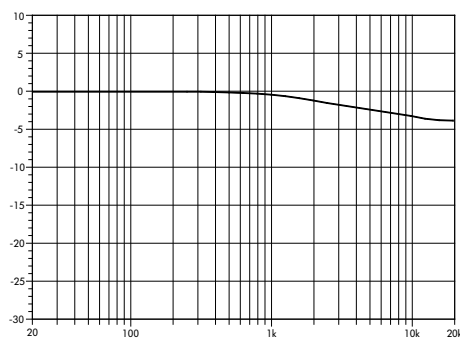

Fig. 7: Frequency response correction of HFA circuit

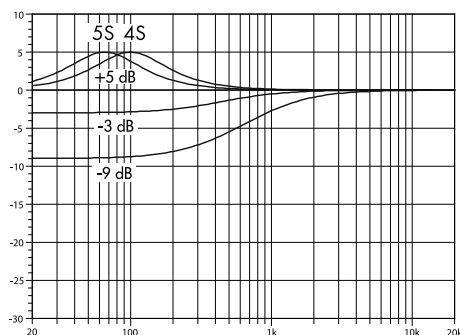

Fig. 8: Frequency response correction of the CPL circuit

CPL circuit

The CPL (Coupling) circuit compensates for coupling effects between the cabinets when building closely coupled arrays. CPL begins gradually around 1 kHz, with the maximum attenuation below 200 Hz. To achieve a balanced frequency response, the CPL circuit can be set to dB attenuation values between 0 and -9.

Positive CPL values create an adjustable low frequency boost (0 to +5 dB) and can be set when the system is used in full range mode without subwoofers.

2.4 Dispersion characteristics

The following graphs show dispersion angle over frequency of a single cabinet plotted using lines of equal sound pressure (isobars) at -6 dB and -12 dB.

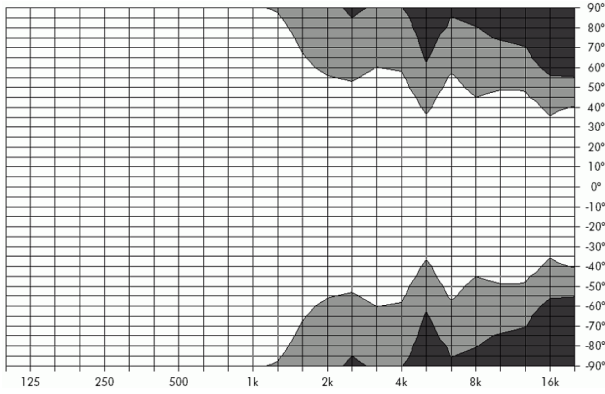

Fig. 9: Isobar diagram horizontal



4S

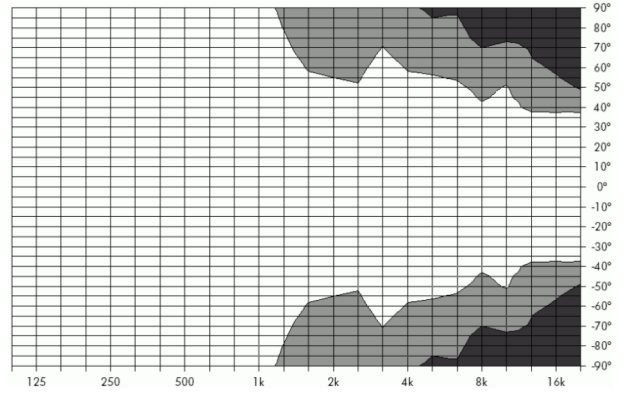

Fig. 10: Isobar diagram vertical

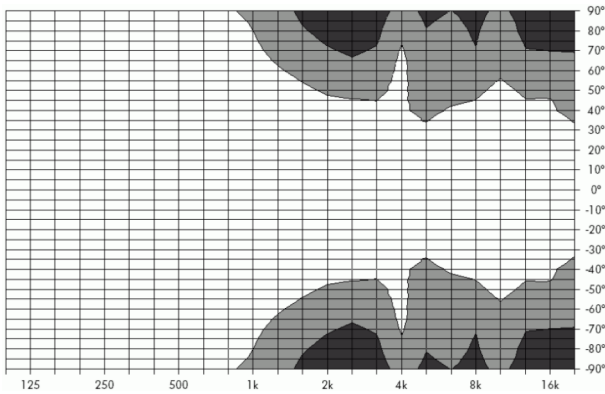
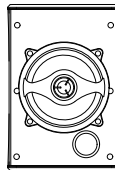

Fig. 11: Isobar diagram horizontal



5S

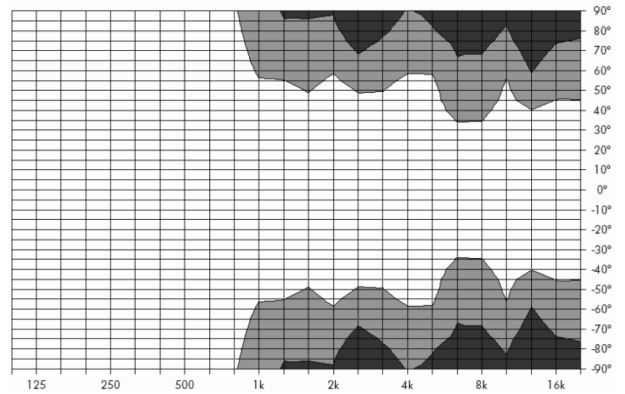

Fig. 12: Isobar diagram vertical

2.5 Technical specifications

4S system data

Frequency response (-5 dB standard mode)	130 Hz - 20 kHz
Frequency response (-5 dB CUT mode)	180 Hz - 20 kHz
Max. sound pressure (1 m, free field)	
with 10D/D6	114 dB
with 30D/D20/D12	115 dB
with D80	115 dB
..... (SPLmax peak, pink noise test signal with crest factor of 4)	

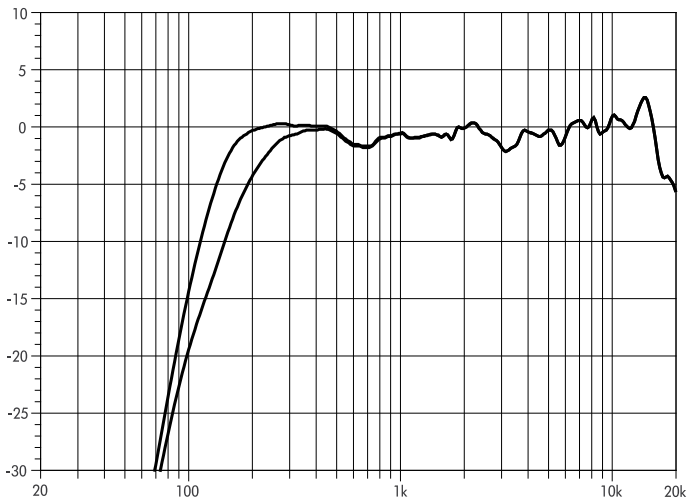

Fig. 13: 4S frequency response, standard and CUT modes

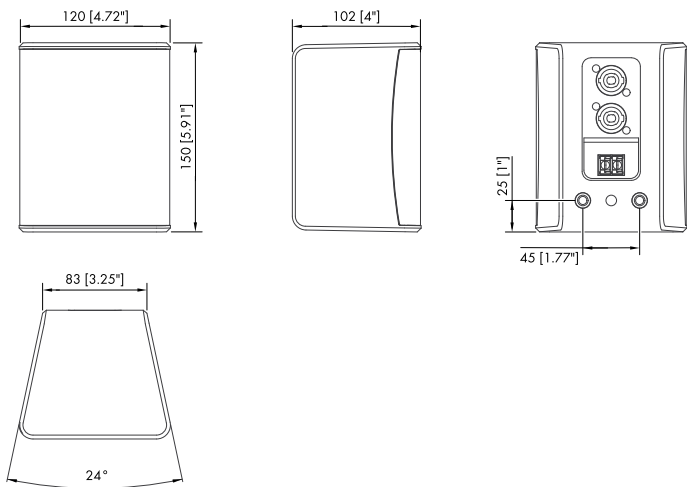

Fig. 14: 4S cabinet dimensions in mm [inch]

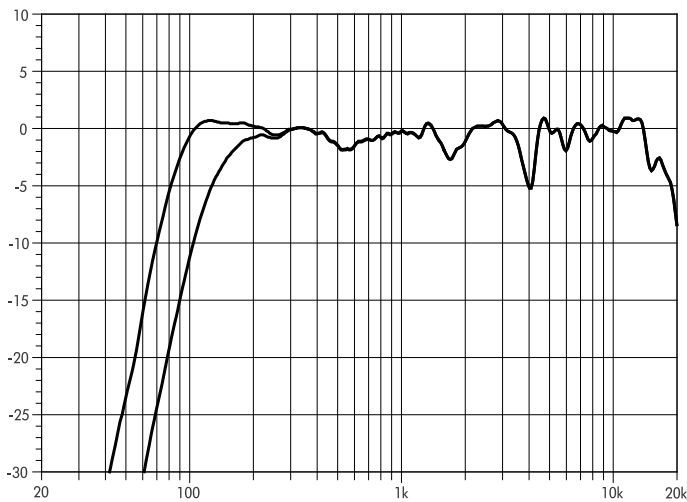

Fig. 15: 5S frequency response, standard and CUT modes

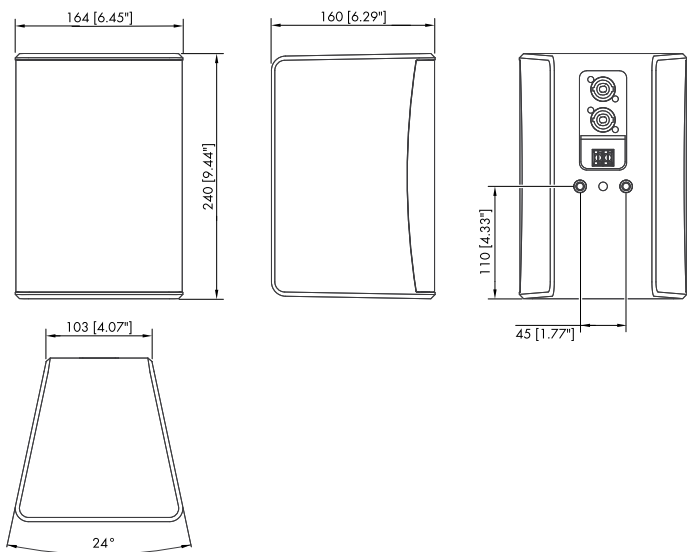

Fig. 16: 5S cabinet dimensions in mm [inch]

4S loudspeaker

Nominal impedance	16 ohms
Power handling capacity (RMS/peak 10 ms)	60/400 W
Nominal dispersion angle (hor. x vert.)	100° conical
Components	4" driver with neodymium magnet
	0.75" dome tweeter, coaxially mounted
	Passive crossover network
Connections	2 x NL4
	1 x screw terminal block (ST - up to 4 mm ² /AWG 11)
Pin assignments	NL4: 1+/1-
Weight	1 kg (2.2 lb)

5S system data

Frequency response (-5 dB standard mode)	80 Hz - 20 kHz
Frequency response (-5 dB CUT mode)	130 Hz - 20 kHz
Max. sound pressure (1 m, free field)	
with 10D/D6	117 dB
with 30D/D20/D12	118 dB
with D80	118 dB
	(SPLmax peak, pink noise test signal with crest factor of 4)

5S loudspeaker

Nominal impedance	16 ohms
Power handling capacity (RMS/peak 10 ms)	60/400 W
Nominal dispersion angle (hor. x vert.)	100° conical
Components	5" driver with ferrite magnet
	1" dome tweeter, coaxially mounted
	Passive crossover network
Connections	2 x NL4
	1 x screw terminal block (ST - up to 4 mm ² /AWG 11)
	WR option: Faston type connector (2 x 6.3 mm), female
Pin assignments	NL4: 1+/1-
	WR option: Brown: (+) / Blue: (-)
Weight	2.5 kg (5.5 lb)

3.1 Conformity of loudspeakers

This declaration applies to:

d&b Z1510 4S loudspeaker

d&b Z1520 5S loudspeaker

manufactured by d&b audiotechnik GmbH & Co. KG.

All product variants are included, provided they correspond to the original technical version and have not been subject to any later design or electromechanical modifications.

We herewith declare that said products are in conformity with the provisions of the respective directives including all applicable amendments.

Detailed and applicable declarations are available on request and can be ordered from d&b or downloaded from the d&b website at www.dbaudio.com.

WEEE-Reg.-Nr. DE: 13421928

3.2 WEEE Declaration (Disposal)

Electrical and electronic equipment must be disposed of separately from normal waste at the end of its operational lifetime.

Please dispose of this product according to the respective national regulations or contractual agreements. If there are any further questions concerning the disposal of this product, please contact d&b audiotechnik.

