

XS

12S/12S-D
Manual 1.4 en

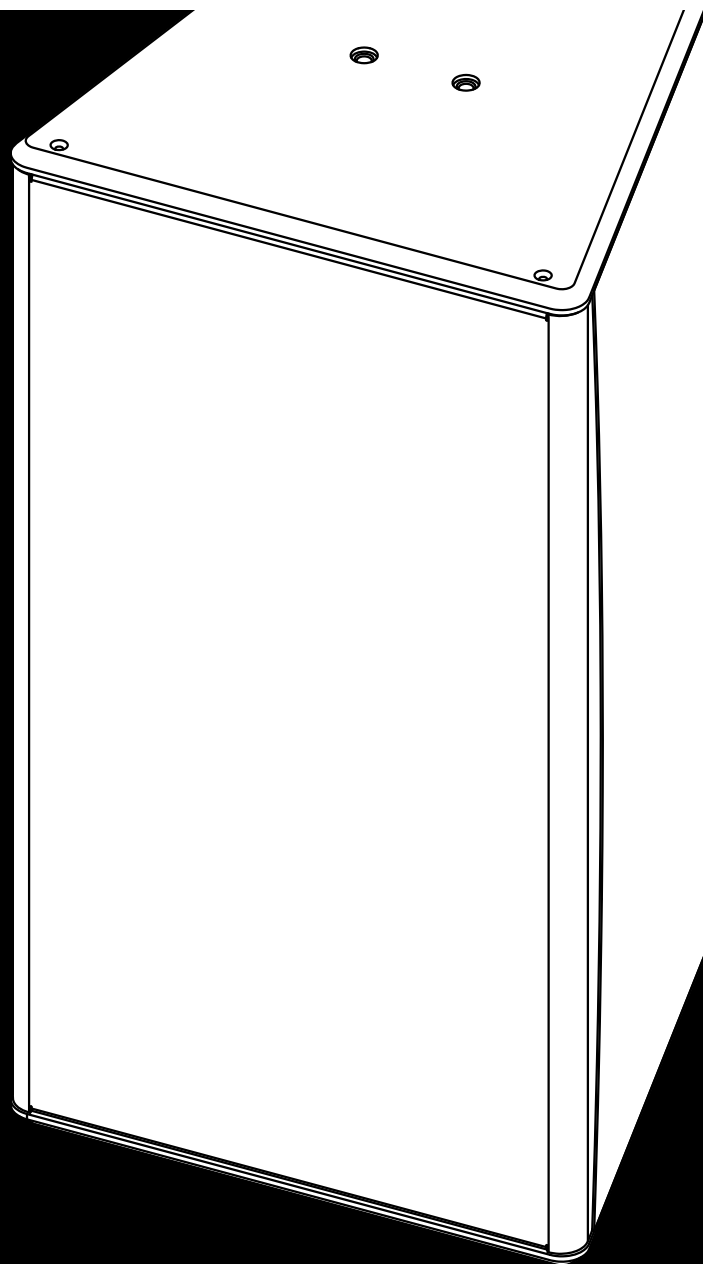

General information

12S/12S-D Manual

Version: 1.4 en, 10/2018, D2612.EN .01

Copyright © 2018 by d&b audiotechnik GmbH & Co. KG; all rights reserved.

Keep this document with the product or in a safe place so that it is available for future reference.

When reselling this product, hand over this document to the new owner.

d&b audiotechnik GmbH & Co. KG
Eugen-Adolff-Str. 134, D-71522 Backnang, Germany
T +49-7191-9669-0, F +49-7191-95 00 00
docadmin@dbaudio.com, www.dbaudio.com

1	Safety precautions	4
1.1	Information regarding the use of loudspeakers.....	4
2	12S/12S-D loudspeaker	5
2.1	Product description.....	5
2.2	Connections.....	5
2.3	Operation.....	8
2.3.1	Controller settings.....	8
2.4	Dispersion characteristics.....	9
2.5	Technical specifications.....	11
3	Manufacturer's Declarations	13
3.1	EU conformity of loudspeakers (CE symbol).....	13
3.2	WEEE Declaration (Disposal).....	13

1.1 Information regarding the use of loudspeakers

Potential risk of personal injury

Never stand in the immediate vicinity of loudspeakers driven at a high level. Professional loudspeaker systems are capable of causing a sound pressure level detrimental to human health. Seemingly non-critical sound levels (from approx. 95 dB SPL) can cause hearing damage if people are exposed to it over a long period.

In order to prevent accidents when deploying loudspeakers on the ground or when flown, please take note of the following:

- When setting up the loudspeakers or loudspeaker stands, make sure they are standing on a firm surface. If you place several systems on top of one another, use straps to secure them against movement.
- Only use accessories which have been tested and approved by d&b for assembly and mobile deployment. Pay attention to the correct application and maximum load capacity of the accessories as detailed in our specific "Mounting instructions" or in our "Flying system and Rigging manuals".
- Ensure that all additional hardware, fixings and fasteners used for installation or mobile deployment are of an appropriate size and load safety factor. Pay attention to the manufacturers' instructions and to the relevant safety guidelines.
- Regularly check the loudspeaker housings and accessories for visible signs of wear and tear, and replace them when necessary.
- Regularly check all load bearing bolts in the mounting devices.

Potential risk of material damage

Loudspeakers produce a static magnetic field even if they are not connected or are not in use. Therefore make sure when erecting and transporting loudspeakers that they are nowhere near equipment and objects which may be impaired or damaged by an external magnetic field. Generally speaking, a distance of 0.5 m (1.5 ft) from magnetic data carriers (floppy disks, audio and video tapes, bank cards, etc.) is sufficient; a distance of more than 1 m (3 ft) may be necessary with computer and video monitors.

2 12S/12S-D loudspeaker

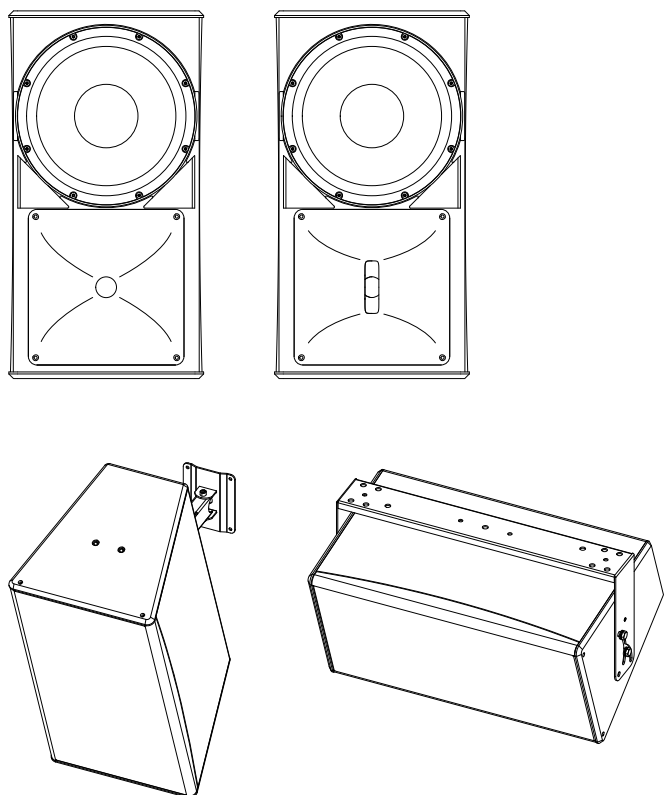

Fig. 1: 12S/12S-D loudspeaker

Rigging examples:

12S with Z5403 Wall mount L.

12S ceiling mounted with Z5411 Horizontal bracket 12S.

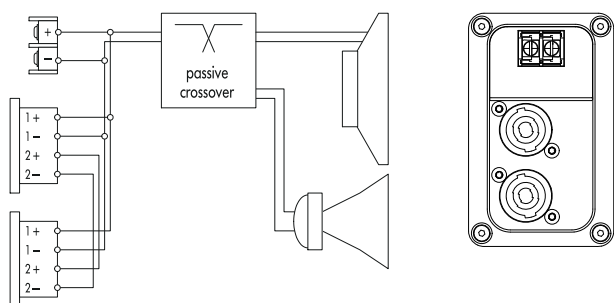

Fig. 2: Connector wiring

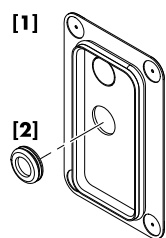

Fig. 3: Cover plate and rubber grommet

2.1 Product description

The 12S and 12S-D are high performance 2-way loudspeakers employing a single 12" neodymium driver in a bass-reflex enclosure and different HF sections for a wide range of installed sound applications. Both models are lightweight passive designs using a 1.4" exit neodymium driver and large horns for accurate pattern control. They provide rotatable dispersion characteristics of 75° x 50° (12S) or 110° x 55° (12S-D).

With a frequency response extending from 48 Hz to 18 kHz, the cabinets can be used as full range systems or supplemented by different subwoofers of the xS- or xA-Series.

The enclosures are constructed from marine plywood with an impact resistant black paint finish. The fronts of the cabinets are protected by a rigid metal grill backed by an acoustically transparent foam.

The cabinets are Ball Impact Resistant according to DIN 18032-3.

Rigging components

The 12S rear panels incorporate two M8 threaded inserts to accept the Z5406 12S Flying bracket or the Z5402 Wall mount M or Z5403 Wall mount L.

Top and bottom panels of the cabinets are each equipped with a pair of M10 threads to connect to different rigging accessories such as Z5411 Horizontal bracket 12S, Z5354 E8/E12 Flying adapter or Z5020/25 Flying adapter 02/03. The M10 threads are covered by dummy caps in cabinet color. The caps must be removed before mounting any accessories.

2.2 Connections

The cabinets are fitted with a pair of NL4 connectors and a two pole screw terminal block (ST). All four pins of both NL4 connectors are wired in parallel. The cabinets use the pin assignments 1+/1-. Pins 2+/2- are designated to active subwoofers.

Pin equivalents of the applicable connector options are listed in the table below.

NL4	1+	1-	2+	2-
ST	+	-	n.a.	n.a.

Fixed cable connection

The 12S and 12S-D loudspeakers are each supplied with a cover plate [1] and a rubber grommet feed through [2]. For indoor operation, these items can be used to hide the connector panel, if required. For unprotected outdoor operation, the connector panel must be covered, i.e. both items must be used to achieve an IP degree of protection of IP34.

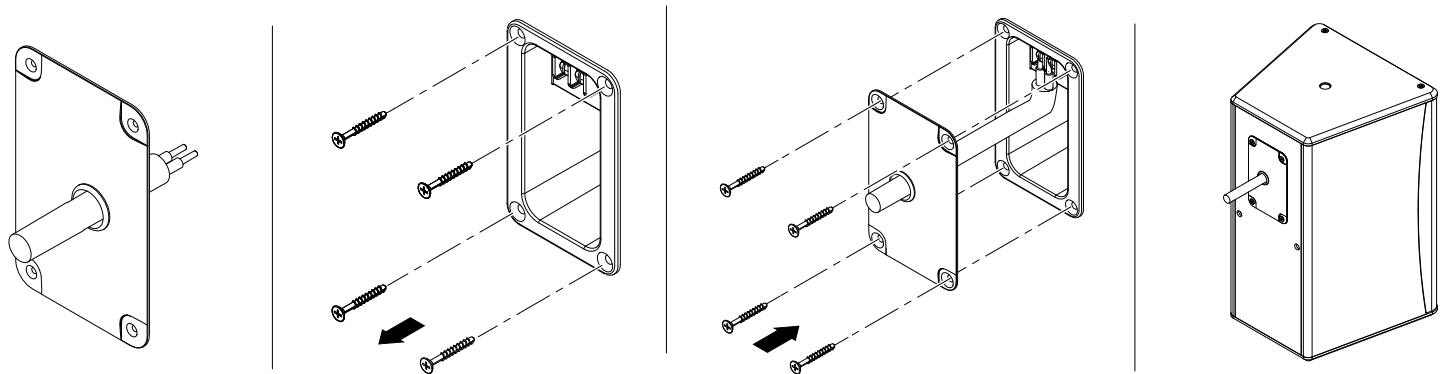

Fig. 4: Installing the fixed cable connection

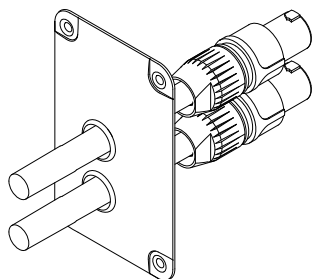

Fig. 5: NL4 cable connection with cover plate [1]

To install the fixed cable connection, proceed as follows:

Tools required: Philips screw driver (#PH2).

1. Prepare the rubber grommet and the connection cable.
2. Remove the knockout opening in the cover plate and attach the rubber grommet correspondingly.
3. Insert the connection cable through the rubber grommet and connect the cable wires to the screw terminal.
⇒ Observe the correct polarity!
4. Undo the four screws of the connector panel.
5. Push the cover plate towards the connector panel until it fits into place.
6. Finally fix the cover plate together with the connector panel using the four screws.

NL4 connection with cover plate

The two NL4 connector sockets of the cabinet's connector panel are located in a recess to allow the use of the cover plate [1] together with NL4 cable connectors, as shown in the graphic opposite.

Note: Neutrik NL4FC type connectors must be used for this option.

The cover plate is equipped with two knockout openings to allow daisy chaining of the loudspeaker.

To use the NL4 connection, proceed in the same manner as described above in the section entitled ⇒ "Fixed cable connection" on page 5.

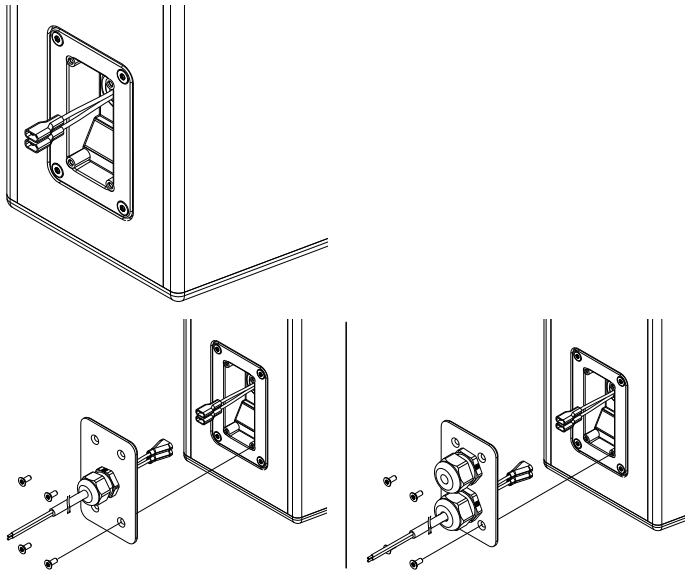

Faston type connector, male single PG (standard), dual PG (optional)

WR option (Weather Resistance)

NOTICE!

The WR option enables operation of loudspeakers in changing ambient conditions, however it is not intended to enable permanent, unprotected operation of loudspeakers outdoors.

- Provide an additional cover over the loudspeakers.
 - Aim the cabinets either horizontally or with a downward tilt.
-

A number of d&b loudspeakers are available in special options suitable for different types of installed applications and environmental conditions. The following options are available for the 12S/12S-D loudspeaker:

- Weather resistant (WR): This option is suitable for outdoor use. The cabinets have an impact and weather protected black PCP (Polyurea Cabinet Protection) finish.
- Sea water resistant (SWR): This option is suitable for outdoor use, especially in wet and acid or salty environments.

WR cabinets are equipped with a recessed connector panel including a Faston type connector (2 x 6.3 mm, female). A cover plate which accepts single or dual PG cable glands (Type PG13.5 for cable diameters from 6 - 12 mm) is enclosed, as shown in the graphic opposite.

To install the fixed connection cable, please proceed as follows:

Tools required: Screw driver (#T20).

Note: Observe the correct polarity of the cable
Brown (+) / Blue (-).

1. Insert the connection cable through the PG screwing and connect the male connector to the female connector.
2. Push the cover plate towards the connector panel until it fits into place.
3. Fix the cover plate to the connector panel using the four countersunk screws.

2.3 Operation

NOTICE!

Only operate d&b loudspeakers with a correctly configured d&b amplifier, otherwise there is a risk of damaging the loudspeaker components.

Applicable d&b amplifiers:

10D/30D/D6/D12/D20/D80.

Application	Setup	Cabinets per channel
12S	12S	2
12S-D	12S-D	2

Within applicable d&b amplifiers, the controller setups are available in Dual Channel or Mix TOP/SUB mode.

2.3.1 Controller settings

For acoustic adjustment the functions CUT, HFA and CPL can be selected.

CUT circuit

Set to CUT, the cabinet low frequency level is reduced. The cabinets are now configured for use with d&b active subwoofers.

HFA circuit

In HFA mode (High Frequency Attenuation), the HF response of the system is rolled off. HFA provides a natural, balanced frequency response when a unit is placed close to listeners in near field or delay use.

High Frequency Attenuation begins gradually at 1 kHz, dropping by approximately 3 dB at 10 kHz. This roll off mimics the decline in frequency response experienced when listening to a system from a distance in a typically reverberant room or auditorium.

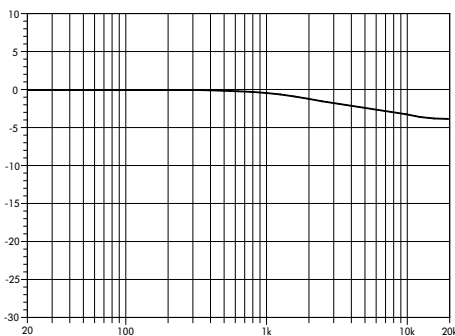

Fig. 6: Frequency response correction of HFA circuit

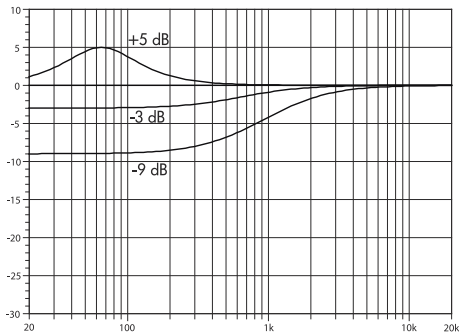

Fig. 7: Frequency response correction of CPL circuit

CPL circuit

The CPL (Coupling) circuit compensates for coupling effects between the cabinets when building closely coupled arrays. CPL begins gradually around 1 kHz, with the maximum attenuation below 200 Hz. To achieve a balanced frequency response, the CPL circuit can be set to dB attenuation values between 0 and -9.

Positive CPL values create an adjustable low frequency boost (0 to +5 dB) and can be set when the system is used in full range mode without subwoofers.

2.4 Dispersion characteristics

The following graphs show dispersion angle over frequency of a single cabinet plotted using lines of equal sound pressure (isobars) at -6 dB and -12 dB.

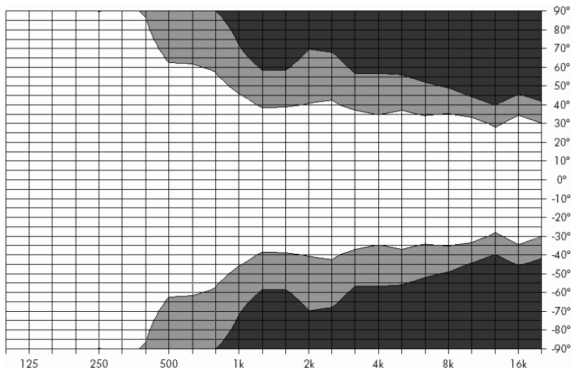
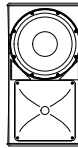

Fig. 8: Isobar diagram horizontal



12S

vertical setup

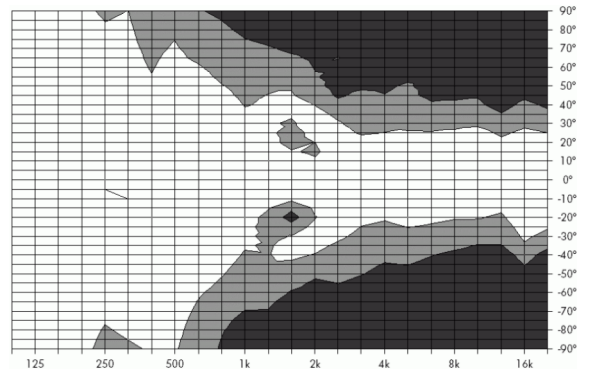

Fig. 9: Isobar diagram vertical

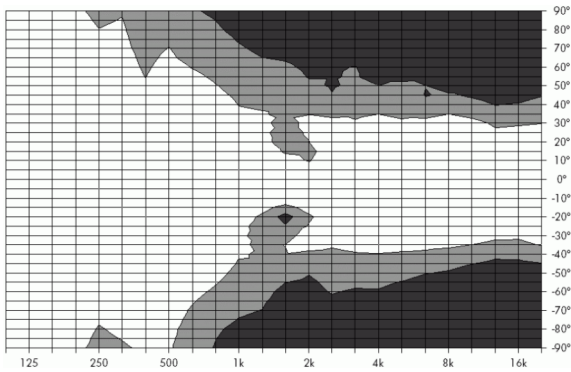
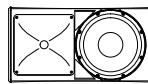

Fig. 10: Isobar diagram horizontal



12S

horizontal setup, horn rotated

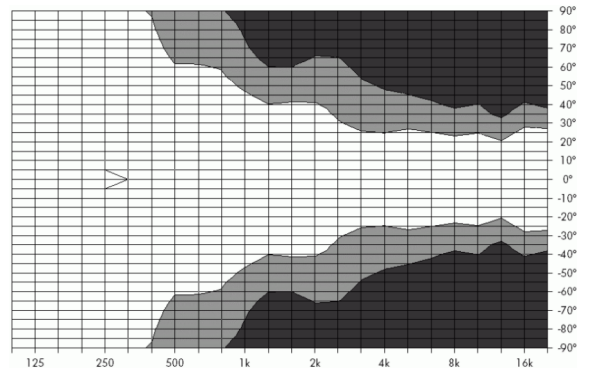

Fig. 11: Isobar diagram vertical

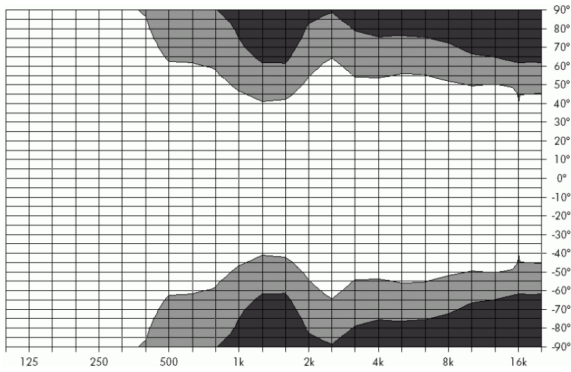
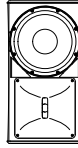

Fig. 12: Isobar diagram horizontal



12S-D

vertical setup

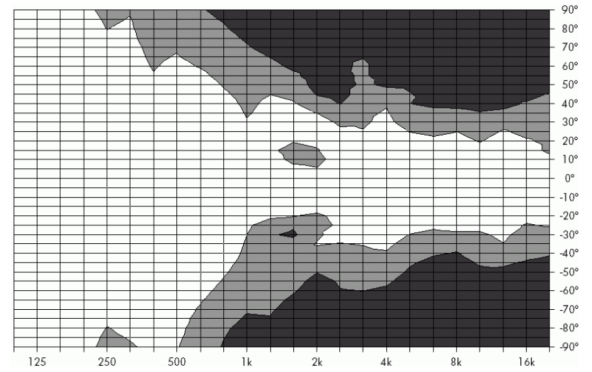

Fig. 13: Isobar diagram vertical

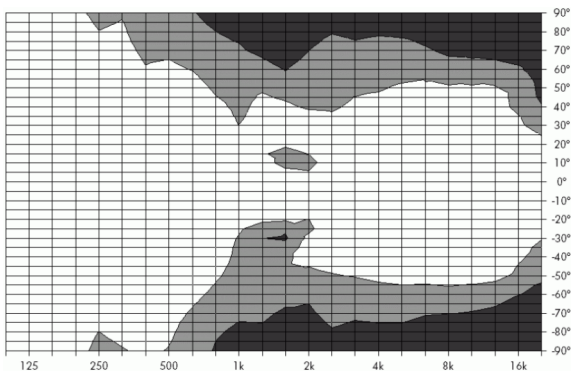
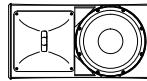

Fig. 14: Isobar diagram horizontal



12S-D

horizontal setup, horn
rotated

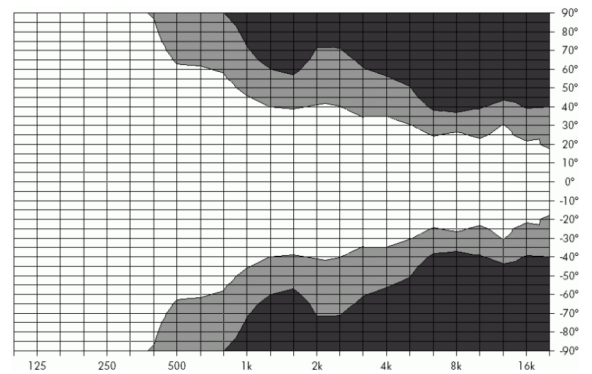
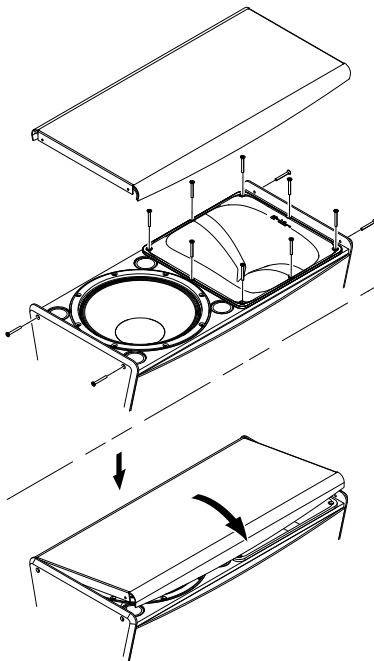

Fig. 15: Isobar diagram vertical



Altering the HF horn dispersion

The HF horn can be rotated through 90°.

Tools required: Philips screwdriver, Torx wrench (T20).

1. Undo the 4 torx screws on the top and bottom panels of the cabinet and remove the front grill.
2. Undo the screws holding the horn flange and rotate the horn.
3. Refit the horn as follows:
 - Make sure the gasket of the horn is in place.
 - Refit the horn.
 - Insert all screws and carefully tighten them clockwise until they fit precisely into the counter sunk holes.
4. Relocate the front grill as follows:
 - Ensure the foam is properly attached to the back of the grill.
 - Starting on one side, attach the grill to the recess of the cabinet's side panel.
 - Fold down the grill into the recess on the other side and make sure it properly fits on all sides.
 - Insert the 4 torx screws and tighten them until they fit precisely into the counter sunk holes.

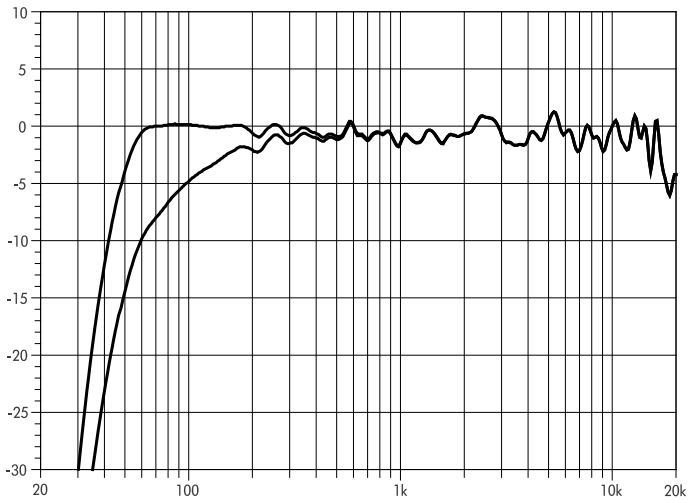

Fig. 16: 12S frequency response, standard and CUT modes

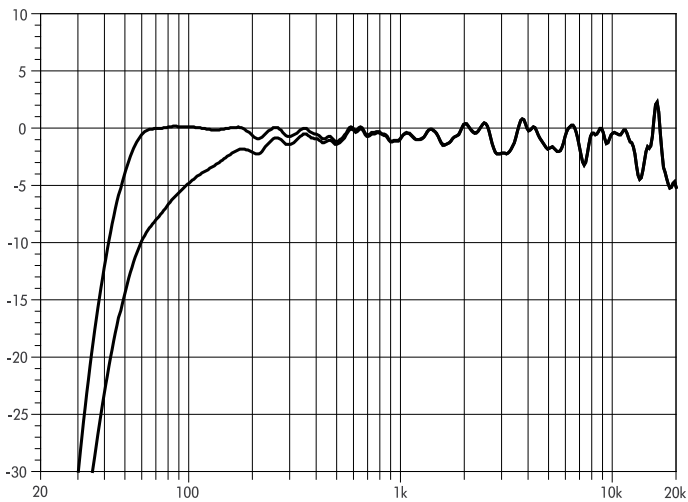

Fig. 17: 12S-D frequency response, standard and CUT modes

2.5 Technical specifications

12S/12S-D system data

Frequency response (-5 dB standard)	48 Hz - 18 kHz
Frequency response (-5 dB CUT mode)	100 Hz - 18 kHz
Max. sound pressure 1 m, free field)	
with 10D/D6	130 dB
with 30D/D20/D12	133 dB
with D80	133 dB
	(SPLmax peak, pink noise test signal with crest factor of 4)

12S/12S-D loudspeaker

Nominal impedance	8 ohms
Power handling capacity (RMS/peak 10 ms)	300/1600 W
Nominal dispersion angle (hor. x vert.) 12S	75° x 50°
Nominal dispersion angle (hor. x vert.) 12S-D	110° x 55°
Components	12" driver with neodymium magnet
	1.4" exit compression driver on rotatable CD horn
	Passive crossover network
Connections	2 x NL4
	1 x screw terminal (ST - up to 4 mm ² /AWG 11)
	WR option: Faston type connector (2 x 6.3mm)
Pin assignment	NL4: 1+/1-
	WR option: brown + / blue -
Weight	17 kg (37 lb)

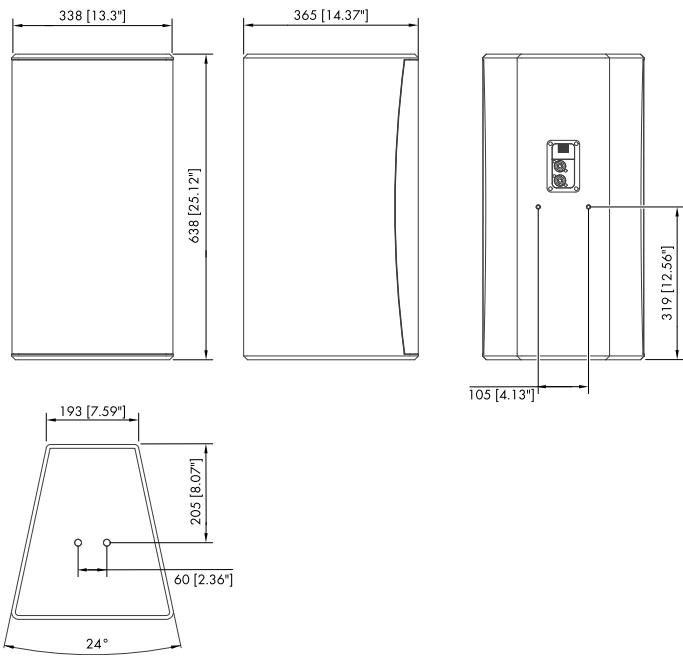

Fig. 18: 12S/12S-D cabinet dimensions in mm [inch]



3.1 EU conformity of loudspeakers (CE symbol)

This declaration applies to:

d&b Z1560 12S loudspeaker

d&b Z1561 12S-D loudspeaker

manufactured by d&b audiotechnik GmbH & Co. KG.

All product variants are included, provided they correspond to the original technical version and have not been subject to any later design or electromechanical modifications.

We herewith declare that said products are in conformity with the provisions of the respective EC directives including all applicable amendments.

A detailed declaration is available on request and can be ordered from d&b or downloaded from the d&b website at www.dbaudio.com.

3.2 WEEE Declaration (Disposal)

Electrical and electronic equipment must be disposed of separately from normal waste at the end of its operational lifetime.

Please dispose of this product according to the respective national regulations or contractual agreements. If there are any further questions concerning the disposal of this product, please contact d&b audiotechnik.

WEEE-Reg.-Nr. DE: 13421928

