

apollo | x16

Thunderbolt 3 Audio Interface
with HEXA Core Realtime UAD Processing

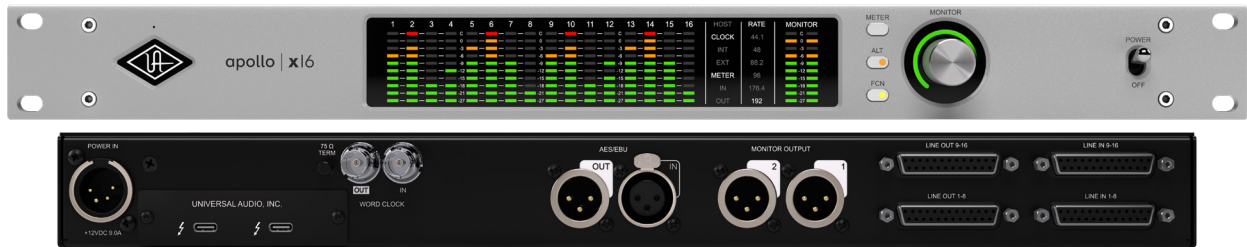

Apollo x16 Gen 2 Hardware Manual

Manual Version 240930

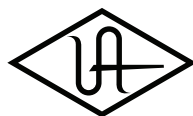

UNIVERSAL AUDIO

www.uaudio.com

A Letter from Bill Putnam Jr.

Thank you for choosing this Apollo audio interface to become a part of your studio. We know that any new piece of gear requires an investment of time and money — and our goal is to make your investment pay off.

Universal Audio interfaces like the Apollo X Gen 2 Series exemplify a commitment to craftsmanship that we've forged over the past 60 years — from our original founding in the 1950s by my father, Bill Putnam Sr., to our current mission to combine the best of both classic analog and modern digital audio technologies.

Starting with its high-quality I/O and elite-class A/D and D/A conversion, Apollo X Gen 2's superior sonic performance serves as its foundation.

This is just the beginning however, as Apollo lets you power the full range of UAD plug-ins in real time, including classic mic preamps, EQs, compressors and limiters, reverbs, guitar amps, and much more. With more than 200 acclaimed UAD plug-ins at your fingertips, the sonic choices are limitless.*

At UA, we are dedicated to the idea that technology should serve the creative process, inspiring our customers to go further. These are the ideals my father embodied with his classic designs, and we believe this spirit lives on today in products like Apollo.

Please feel free to reach out to us via our website www.uaudio.com, and via our social media channels. We look forward to hearing from you, and thank you once again for choosing Universal Audio.

Sincerely,

A handwritten signature in black ink, appearing to read 'Bill Putnam Jr.', with a stylized, cursive script.

Bill Putnam Jr.

*All trademarks are recognized as property of their respective owners. Individual UAD Powered Plug-Ins sold separately.

Contents

Tip: Click any section or page number to jump directly to that page.

A Letter from Bill Putnam Jr.....	2
Introduction	4
Experience the gold standard in audio recording.....	4
Apollo x16 Gen 2 Features	6
Operational Overview.....	9
About Apollo Documentation	11
Additional Resources.....	12
Front Panel	13
Rear Panel	19
Digital I/O.....	20
Analog I/O.....	22
Interconnections.....	24
Installation Notes.....	24
Connection Notes.....	24
Typical Setup	26
Apollo Expanded: Multi-Unit Wiring	27
Software Setup	28
Specifications.....	29
Block Diagram.....	32
DB25 Wiring	33
Troubleshooting.....	34
Notices	35
Important Safety Information.....	35
Manufacturer’s Declarations	36
Technical Support.....	40
Universal Audio Knowledge Base	40
Universal Audio YouTube Channel.....	40
Universal Audio Community Forums	40
Customer Care	40

Introduction

Experience the gold standard in audio recording.

The next generation of Apollo x16 is here — built for pro studios and serious music producers who need 16 channels of highest-resolution audio conversion and HEXA Core DSP processing for connecting your studio equipment and producing large sessions with UAD plug-ins from Neve, Manley, Avalon, SSL, Auto-Tune, and hundreds more.

- Connect your studio gear with 16 x 16 analog I/O via DB-25 connections with switchable +24 dBu headroom settings
- Use onboard HEXA Core DSP to record and mix large sessions using UAD plug-ins in realtime
- Create immersive audio mixes up to 9.1.6 for Dolby Atmos, Auro-3D, Sony 360 Reality Audio, and others
- Work faster with new UAD Console features including Auto-Gain, Plug-In Scenes, Monitor Controller, Immersive Audio, and more
- Mix with confidence in any room or through headphones using Apollo Monitor Correction by Sonarworks®
- Get included UAD plug-ins from Auto-Tune, Fairchild, Teletronix, and more with Essentials+ or Ultimate+ Editions

Connect to Award-Winning Apollo X Sound

With widest dynamic range and lowest distortion ever, Apollo x16 is the only audio interface that connects to your analog gear and patchbays, letting you record and mix with authentic analog sounds in realtime over DB-25 connections with selectable +24 dBu operation.

Hear the Details Like Never Before

Now in its Gen 2 design, Apollo x16 features our highest-resolution A/D and D/A converters to date. And when paired with new features like Apollo Monitor Correction by Sonarworks, this means you'll hear the most accurate representation of your recordings when mixing through monitors or headphones.

Mix Down to Surround

Apollo x16 supports mixing formats up to 9.1.6, so you can create 16-channel immersive audio mixes for Dolby Atmos, Auro-3D, Sony 360 Reality Audio, and others.

Add Hundreds of Effects to Your Rack

Apollo x16 comes in two editions, both delivering a generous suite of UAD plug-ins right out of the box. Build your mix with classic Teletronix LA-2A and 1176 compressors, Pultec EQs, API and SSL channel strips to modern favorites from Auto-Tune, Avalon, and dozens more.

Find Your Perfect Workflow

Easily control all your plug-in routing and monitoring in the UAD Console app. And with the latest features like Bass Management, Immersive Audio up to 9.1.6, and Plug-In Scenes, it's easy to find a flow that fits your needs.

A Hybrid System for Your Mission

Combine Apollo x16's HEXA Core DSP with native processing from your host computer to produce large sessions with complex plug-in chains — a powerhouse hybrid workflow that outpaces any native-only recording setup.

Expand Your Studio as You Grow

Link up to four Apollo x16's for 64 channels of elite-class A/D and D/A conversion, perfect for interfacing with large format recording consoles. Or stack one x16 with other Thunderbolt Apollo rackmount units and control it all from your desktop using Apollo Twin or x4. So no matter how far your music takes you, an Apollo will always be in reach.



*includes the Essentials+ or Ultimate+ Editions. Other UAD plug-ins available separately.
All trademarks are property of their respective owners.*

Apollo x16 Gen 2 Features

Key Features

- 18 x 20 Thunderbolt 3 audio interface with HEXA Core DSP plug-in processing
- Two DB-25 inputs (line 1-16), stereo AES I/O (XLR), word clock I/O (BNC)
- Two monitor outs (XLR), two DB-25 outputs (line 1-16 or ALT / 9.1.6 surround)
- Elite-class Apollo X Gen 2 converters with 24-bit / 192 kHz resolution featuring Dual-Crystal Clocking for ultra-low jitter at all sample rates
- Flagship D/A for critical monitoring and playback with 133 dB dynamic range and astonishingly low THD of -129 dB
- Calibrate your main monitor outputs (stereo or immersive) with Apollo Monitor Correction powered by Sonarworks®
- Fully-featured monitor controller with alternate speaker switching and integrated talkback for easy communication with talent
- ALT monitoring support in all monitor modes (2 x ALT mon for stereo, 1 x ALT mon for immersive)
- Updated UAD Console app featuring Plug-In Scenes, subwoofer integration with Bass Management, immersive audio support, and more
- Onboard DSP supports over 200 UAD plug-ins via VST, AU, and AAX 64 formats in all major DAWs
- Includes up to 100+ UAD plug-ins with Essentials+ or Ultimate+ Editions
- Compatible with LUNA, Logic Pro, Pro Tools, Cubase, Ableton Live, and more
- Expandable with Thunderbolt Apollo interfaces and Dante via Apollo x16D
- Free industry-leading technical support from knowledgeable audio engineers



All Features

Audio Interface

- Sample rates up to 192 kHz at 24-bit word length
- 16 x 18 simultaneous analog input/output channels:
 - 16 channels of analog-to-digital conversion via line inputs on dual DB25 connectors
 - 18 channels of digital-to-analog conversion:
 - 16 line outputs via dual DB25 connectors
 - Stereo monitor outputs via dual XLR connectors
- Adjustable reference levels for all analog I/O (+4 dBu or -10 dBV)
- Two channels of AES/EBU digital I/O with optional sample rate conversion on input
- Front panel pre-fader metering of analog signal input or output levels
- Two Thunderbolt 3 ports for daisy-chaining other Thunderbolt devices

Monitoring

- Independently-addressable stereo monitor outputs (separate from the 16 line outputs)
- Front panel control of monitor levels and muting
- Front panel pre-fader metering of monitor bus levels
- Digital AES/EBU outputs can mirror the analog monitor outputs

UAD-2 Inside

- HEXA core DSP featuring six SHARC® processors
- Realtime UAD Processing on all analog and digital inputs
- Same features and functionality as other UAD-2 devices when used with DAW
- Can be combined with other UAD-2 devices for increased mixing DSP
- Complete UAD plug-ins library available at the UA online store

Software

UAD Console application

- Analog-style control interface for realtime monitoring and tracking
- Enables Realtime UAD Processing with UAD plug-ins
- Remote control of Apollo features and functionality
- Virtual I/O for routing DAW tracks through UAD Console

Console Recall plug-in

- Saves UAD Console configurations inside DAW sessions for easy recall
- Convenient access to UAD Console's monitor controls via DAW plug-in
- VST, AAX 64, and Audio Units plug-in formats

UAD Meter & Control Panel application

- Configures global UAD settings and monitors system usage

Other

- Easy firmware updates
- 1U rack-mountable form factor
- One year warranty includes parts and labor

Package Contents

- Apollo x16 Gen 2 audio interface
- External power supply and region-specific AC cable
(USA, EU, UK, ANZ, or Japan)
- Set of (4) rack-mount screws
- Getting Started URL card

Operational Overview

Audio Interface

First and foremost, Apollo x16 Gen 2 is a premium 16 x 18 Thunderbolt 3 audio interface with elite-class 24-bit/192 kHz audio conversion. Apollo connects to the outputs and inputs of other audio gear, and performs analog-to-digital (A/D) and digital-to-analog (D/A) audio conversions on the gear's signals. The digital audio signals are routed into and out of your host computer via the high-speed PCIe protocol, which is carried on a single Thunderbolt 3 cable.

Apollo leverages Universal Audio's expertise in DSP acceleration, UAD Powered Plug-Ins, and analog hardware design by integrating the latest cutting edge technologies in high-performance A/D-D/A conversion, DSP signal reconstruction, and connectivity. Apollo acts as an audio interface with integrated DSP effects for tracking and monitoring, a fully integrated UAD-2 DSP accelerator for mixing and mastering, as well as a complete monitoring controller.

About Realtime UAD Processing

Apollo has the ability to run UAD Powered Plug-Ins in realtime. Apollo's groundbreaking DSP + FPGA technology enable UAD plug-ins to run with latencies in the sub-2 ms range, and multiple plug-ins can be stacked in series without additional latency. Realtime UAD Processing facilitates the ultimate sonic experience while monitoring and/or tracking.

Note: Apollo, as with other UAD-2 devices, can only load UAD Powered Plug-Ins, which are specifically designed to run on UAD-2 DSP accelerators. Native (host CPU-based) plug-ins cannot run on the UAD-2 DSP.

UAD Console Software

Important: UAD Console is integral to unleashing the power of Apollo. For complete details about how to use UAD Console and Realtime UAD Processing, refer to the [UAD Console Manual](#).

The UAD Console companion software program is used to control Apollo mixing and input monitoring with Realtime UAD Processing, access the audio interface I/O settings, Unison technology, and more. UAD Console's analog-style workflow is designed to provide quick access to the most commonly needed features in a familiar, easy-to-use mixer interface.

Realtime UAD Processing is a special function that is available only within UAD Console or LUNA. All of Apollo's analog and digital inputs can perform Realtime UAD Processing simultaneously, and UAD Console inputs with (or without) Realtime UAD Processing can be routed into the DAW for recording.

UAD Console controls Apollo's digital mixer so you can monitor Apollo's inputs (with or without Realtime UAD Processing) live, without any other audio software such as a DAW.

UAD Powered Plug-Ins in a DAW

Apollo and UAD plug-ins can also be used with a DAW without using UAD Console. UAD plug-ins loaded within the DAW operate like other (non-UAD) plug-ins, except the processing occurs on Apollo DSP instead of the host computer's processor. In this scenario, UAD plug-ins are subject to the latencies incurred by the DAW's I/O buffering.

For details about using UAD Powered Plug-Ins in a DAW, see the [Apollo Software Manual](#).

Standalone Use

Although UAD Console is required to use all Apollo features, the hardware unit can be used as a digital mixer with limited functionality without a Thunderbolt 3 connection to a host computer.

All currently active I/O assignments, signal routings, and monitor settings are saved to internal firmware when Apollo is powered down and persist when power is re-applied. Therefore the last-used settings are always available even when a host computer is not connected.

Note that UAD plug-in instantiations in UAD Console are not retained on power down, because the plug-in files reside on the host computer. However, if UAD plug-ins are active when Apollo's connection to the host system is lost (if the Thunderbolt 3 cable is unplugged), the current UAD-2 plug-in configurations remain active for processing until Apollo is powered down.

Note: Standalone use is unavailable when cascading multiple Apollo units.



About Apollo Documentation

Documentation for Apollo and UAD Powered Plug-Ins are separated by areas of functionality, as described below. All user manuals are available at help.uaudio.com.

Some manual files are in PDF format. PDF files require a free PDF reader application such as Preview (macOS) or Edge (Windows).

Apollo Hardware Manuals

Each Apollo model has a unique hardware manual. The Apollo hardware manuals contain complete hardware-related details about one specific Apollo model. Included are detailed descriptions of all hardware features, controls, connectors, and specifications.

Note: Each hardware manual contains the unique Apollo model in the file name.

Apollo Software Manual

The Apollo Software Manual is a companion guide to the Apollo hardware manuals. It contains detailed information about how to configure and control Apollo software features. Refer to the Apollo Software Manual to learn how to operate the software tools and integrate Apollo's functionality into the DAW environment.

Note: Each Apollo connection protocol (Thunderbolt, FireWire, USB) has a unique software manual.

UAD Console Manual

UAD Console is Apollo's companion software, for controlling up to four Apollo units and their digital mixing and low-latency monitoring capabilities. UAD Console is where you configure and operate Realtime UAD Processing and Unison with UAD-2 plug-ins.

UAD Plug-Ins Manual

The features and functionality of all individual UAD-2 Powered Plug-Ins is detailed in the UAD Plug-Ins Manual. Refer to that document to learn about the operation, controls, and user interface of each UAD-2 plug-in that is developed by Universal Audio.

Direct Developer Plug-In Manuals

UAD Powered Plug-Ins includes plug-in titles created by our Direct Developer partners. Documentation for these 3rd-party plug-ins are separate files written and provided by the plug-in developers. The file names for these plug-in manuals are the same as the plug-in titles.

UAD System Manual

The UAD System Manual is the complete operation manual for Apollo's UAD-2 functionality and applies to the entire UAD-2 product family. It contains detailed information about installing and configuring UAD devices, the UAD Meter & Control Panel application, buying optional plug-ins at the UA online store, and more. It includes everything about UAD except Apollo-specific information and individual UAD plug-in descriptions.

Accessing Documentation

Any of these methods can be used to access documentation:

- Choose Documentation from the Help menu within the UAD Console application
- Click the Product Manuals button in the Help panel within the UAD Meter & Control Panel application
- All manuals are available online at help.uaudio.com

Host DAW Documentation

Each Digital Audio Workstation application has its own particular methods for configuring and using audio interfaces and plug-ins. Refer to the host DAW's documentation for specific instructions about using audio interface and plug-in features within the DAW.

Tip: The LUNA application manual is available [here](#).

Hyperlinks

Links to other manual sections and web pages are [highlighted in blue text](#). Click a hyperlink to jump directly to the linked item.

Tip: Use the back button in the PDF reader application to return to the previous page after clicking a hyperlink.

Additional Resources

For additional resources, or if you need to contact Universal Audio for assistance, see the [Technical Support](#) page.

Front Panel

This section describes the features and functionality of all controls and visual elements on the Apollo x16 front panel.

*Tip: All front panel functions except **METER** and **POWER** can be controlled remotely with the included UAD Console software application. Changes made with the front panel controls are mirrored in the UAD Console application, and vice versa.*

(1) Power Indicator (UA Logo)

The Universal Audio logo illuminates when the external power supply is properly connected to the AC outlet and the power input on the rear of the unit, and the Power switch (#14) is in the up position.

(2) Talkback Microphone

The built-in talkback mic is located inside of this hole. The talkback function is configured and operated in the included UAD Console software application.

Caution: *The talkback microphone is sensitive. To avoid equipment damage, do not insert any object into the mic hole, apply pressurized air into the mic hole, or use a vacuum over the mic hole.*

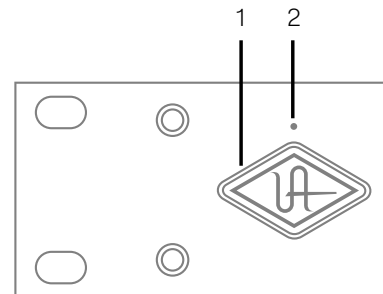

Power indicator and talkback microphone

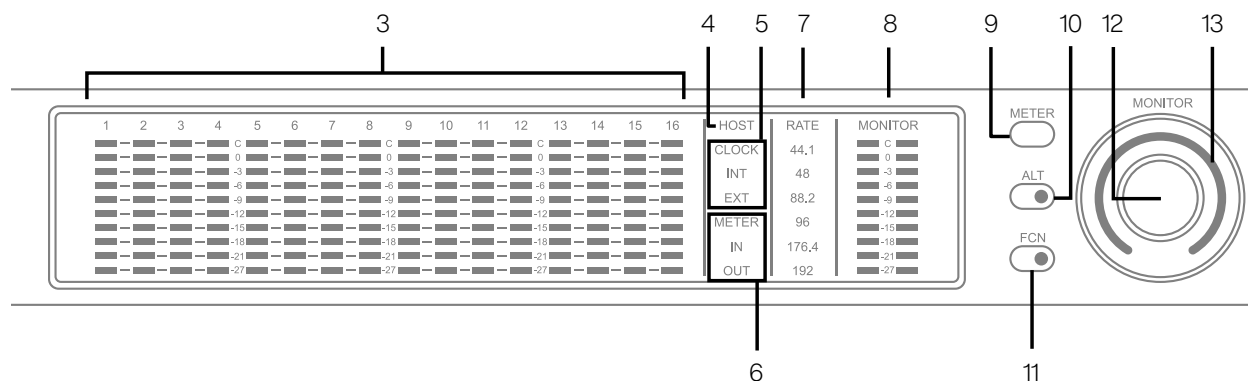

Main Apollo x16 front panel elements

(3) Channel Level Meters

The 10-segment LED channel meters display the input or output signal peak levels for analog channels 1 – 16. Input or output metering is selected with the METER switch (#9), and the input/output state is shown by the METER indicators (#6).

The dB values of the meter LEDs are indicated between the meters for channels 4 & 5 and 12 & 13. “0” indicates a level of 0 dBFS. When digital clipping occurs (when 0 dBFS is exceeded), the red “C” (clip) LED illuminates.

Input Channel Meters

When set to INPUT, the channel meters display the signal peak input levels for analog channels 1 – 16 at the input to the A/D converters. Avoid digital clipping at the channel's A/D converter by reducing the output level of the device connected to the channel's input.

Output Channel Meters

When set to OUTPUT, the channel meters display the signal peak output levels for analog channels 1 – 16 at the output of the D/A converters.

(4) HOST Indicator

The HOST indicator displays the status of the Thunderbolt connection to the host computer system. The possible states are:

Lit – The unit is communicating with the host computer and operating normally.

Unlit – The unit is starting up or it is not recognized by the host computer. Verify software installation and Thunderbolt connections.

Red – System error. Please contact UA technical support if the issue persists.

(5) CLOCK Indicators

The clock source and status are displayed with these indicators. Either internal (INT) or external (EXT) is displayed. The clock source is set within the UAD Console application; see the [UAD Console Manual](#) for details.

Internal Clock

When set to internal clock, the INT indicator is illuminated white.

External Clock

Apollo x16 can use an external digital clock source from the Word Clock or AES/EBU inputs. The EXT indicator has two possible states:

White – When set to external clock and a valid clock signal is detected at the specified port, the EXT indicator is illuminated white and Apollo x16 is synchronized to the external clock source.

Red – When set to external clock and a valid clock signal is NOT detected at the specified port, the EXT indicator is illuminated red and the internal clock remains active instead. In this situation, if/when the specified external clock becomes available, Apollo x16 switches back to the external clock, and the EXT indicator is illuminated and white.

Important: *When set to use any external clock source, Apollo x16's sample rate must be manually set to match the sample rate of the external clock.*

(6) METER Indicators

These indicators show the current state of the Channel Level Meters (#3). The current state is changed with the METER switch (#9).

IN – When IN is illuminated, the channel meters display analog input signal levels.

OUT – When OUT is illuminated, the channel meters display analog output signals levels.

(7) Sample Rate Indicators

These indicators display the current sample rate setting for A/D and D/A conversion. The sample rate is set within the UAD Console application or the host DAW; see the [UAD Console Manual](#) for details.

(8) Monitor Output Level Meters

The 10-segment LED meters display the signal peak output levels of the rear panel Left & Right Monitor outputs at the output of the D/A converters. These meters are before the Monitor Level control (pre-fader) and reflect the D/A converter levels regardless of the current Monitor Level and Headphone Level knob settings.

The dB values of the monitor meter LEDs are indicated between the left and right channel meters. When digital clipping occurs, the red “C” (clip) LED illuminates.

If the monitor output level clips, reduce the monitor output level within the DAW and/or reduce the output level of individual channels feeding the monitor output bus within the UAD Console application.

(9) Meter Switch

This switch determines whether the Channel Level Meters (#3) are displaying input levels or output signal levels. Pressing the switch toggles the state of the meters and the Meter Indicators (#6).

(10) Monitor ALT Switch

When ALT monitoring is configured in the Hardware panel within the UAD Console Settings window (when ALT COUNT is set to a non-zero value), this switch toggles between the main monitor outputs and the ALT 1 outputs (line outputs 1 & 2).

When the ALT switch is engaged:

- The monitor signals are routed to outputs 1 & 2 instead of the main monitor outputs.
- The orange LED within the switch is illuminated.
- The Monitor Level Indicator (#13) is orange instead of green.

For complete details about how to configure and use the ALT monitoring features, refer to the [UAD Console Manual](#).

Tip: ALT 2 outputs (line outputs 3 & 4) can be selected with the FCN switch (#11) when configured in UAD Console Settings, or in the MONITOR column within the UAD Console application.

(11) Monitor Function Switch (FCN)

This is an assignable switch that can be configured to control one of three monitoring functions. The function of the switch is configured with the FCN SWITCH ASSIGN menu in the Hardware panel within the UAD Console Settings window. Refer to the [UAD Console Manual](#) for details.

The amber LED within the switch flashes when the monitoring function is active. The function is toggled with the switch is pressed again. The available functions are:

ALT 2 – Selects the ALT 2 monitor speakers. The monitor signals are routed to outputs 3 & 4 instead of the main monitor outputs, and the Monitor Level Indicator ring (#13) is amber instead of green when ALT 2 is active.

MONO – Sums the left and right channels of the stereo monitor mix into a monophonic signal. The Monitor Level Indicator ring (#13) flashes when MONO is active.

DIM – Attenuates the signal level at the monitor outputs by the dB amount set in the CONTROL ROOM strip within the UAD Console application. The Monitor Level Indicator ring (#13) flashes when DIM is active.

TALKBACK – Activates the talkback mic and the DIM function. Talkback is active when the button is lit. Press and release the button quickly to latch talkback ON. To momentarily activate the function and deactivate when the button is released, press for longer than 0.5 seconds. The Monitor Level Indicator ring (#13) flashes when talkback is active.

Note: When more than one Apollo interface is connected in a multi-unit configuration, the FCN switch is operable on the designated monitor unit only.

(12) Monitor Level & Mute Knob

This rotary encoder serves two functions. Rotating the knob adjusts the monitor output level, and pressing the knob mutes the monitor outputs.

Monitor Level

Rotating the knob clockwise increases the signal level at the Left & Right Monitor Outputs on the rear panel. If ALT monitor outputs are configured and active, this knob controls the signal level at the ALT monitoring line outputs.

Monitor Mute

Pressing the Monitor knob toggles the mute state of the signals at the Left & Right Monitor Outputs on the rear panel. If ALT monitoring is configured in the Hardware panel within the UAD Console Settings window (when ALT COUNT is a non-zero value), the ALT monitor outputs are also muted by this control.

When the monitor outs are muted, the Monitor Level Indicator ring (#13) is red.

(13) Monitor Level & Monitor State Indicator

Tip: The Monitor Level and Monitor State indications are reflected in the Monitor column within the UAD Console application.

Monitor Output Level Indicator

The relative signal level at the rear panel monitor outputs (and ALT monitor outputs, if configured) is indicated by the illuminated ring surrounding the Monitor Level knob.

This indicator is after the Monitor Level control (post fader). The ring indicates relative gain levels and is not calibrated to indicate any specific dB value.

Tip: Precise numerical dB gain values for the Monitor Level Knob are displayed within the UAD Console application.

Monitor State Indicator

The color of the indicator ring indicates the current state of the monitor outputs:

Green – The main monitor outputs are active with variable level control.

Red – The main monitor outputs (and ALT monitor outputs, if configured) are muted.

Orange – The ALT 1 monitor outputs are active.

Yellow – The FCN switch is active and assigned ALT 2.

Flashing – The monitor DIM, MONO, and/or TALKBACK functions are active.

(14) Power Switch

This switch applies power to Apollo x16. When the unit is powered on, the Universal Audio logo (#5) is illuminated. The external power supply must be properly connected for this switch to function.

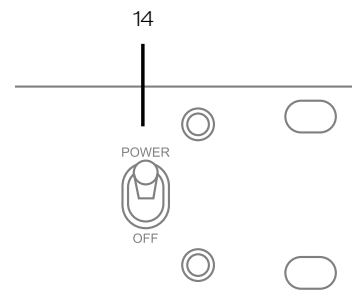

Rear Panel

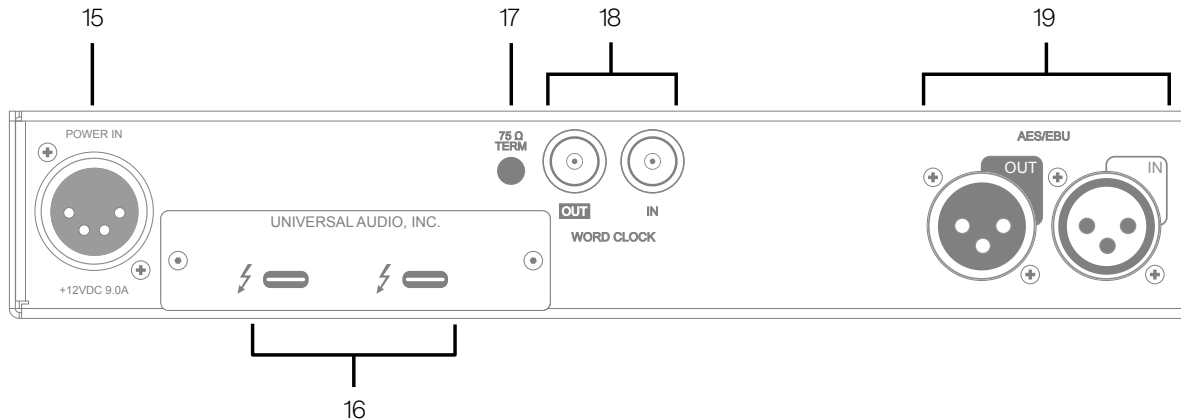

Apollo x16 rear panel (digital portion)

(15) Power Input

The included external power supply connects to this 4-pin locking XLR jack. Apollo x16 requires 12 volts DC power and draws a maximum of 72 watts (30 watts typical).

To eliminate risk of circuit damage, connect only the factory-supplied power supply. Use the Power switch on the front panel to power the unit on and off.

Important: Do not disconnect the power supply while Apollo x16 is in use, and confirm the Power switch is in the “off” position before connecting or disconnecting the power supply.

(16) Thunderbolt 3 Ports

Apollo x16 has two Thunderbolt 3 ports. One port is used to connect Apollo x16 to a Thunderbolt 3 port on the host computer. Thunderbolt 3 peripheral devices may be serially connected (daisy-chained) to the second Thunderbolt 3 port.

When Apollo x16 is properly communicating with the host computer via Thunderbolt, the HOST indicator (#4) illuminates.

Note: Apollo x16 can be used with Thunderbolt 1 and Thunderbolt 2 ports on Apple Mac computers via the Apple Thunderbolt 3 to Thunderbolt 2 Adapter. Connections to Thunderbolt 1 or Thunderbolt 2 ports on Windows PCs are not supported.

Thunderbolt Bus Power

Per the Thunderbolt specification, bus power is supplied to downstream (daisy-chained) Thunderbolt peripheral devices. Apollo x16 must be powered on for the daisy-chained peripheral to receive Thunderbolt bus power.

Digital I/O

(17) 75 Ohm Word Clock Termination Switch

This switch provides internal 75-ohm word clock input signal termination when required. Word clock termination is active when the switch is engaged (depressed).

Apollo x16's termination switch should only be engaged when Apollo x16 is set to sync to external word clock and it is the last device at the receiving end of a word clock cable. For example, if Apollo x16 is the last "slave" unit at the end of a clock chain (when Apollo x16's word clock OUT port is not used), termination should be active.

(18) Word Clock I/O

Word Clock In

Apollo x16's internal clock can be synchronized (slaved) to an external master word clock. This is accomplished by setting Apollo x16's clock source to Word Clock within the UAD Console application, connecting the external word clock's BNC connector to Apollo x16's word clock input, and setting the external device to transmit word clock. If Apollo x16 is the last device in the clock chain, the Termination switch (#17) should be engaged.

***Important:** Apollo x16's sample rate must be manually set to match the incoming clock's sample rate.*

***Note:** Apollo x16 can be synchronized to an external "1x" clock signal only. Superclock, overclocking, and subclocking are not supported.*

Word Clock Out

This BNC connector transmits a standard (1x) word clock when Apollo x16 is set to use its internal clock. The clock rate sent by this port matches the current system sample rate, as specified within the UAD Console application.

When Apollo x16 is set to use external word clock as its clock, Apollo x16 is a word clock slave. If the incoming external word clock is within $\pm 4\%$ of a supported sample rate (44.1 kHz, 48 kHz, 88.2 kHz, 96 kHz, 176.4 kHz, 192 kHz), Word Clock Out will mirror Word Clock In with a slight phase delay (about 40ns).

Because Apollo x16's word clock output is not a true mirror of the word clock input, word clock out should not be used to daisy chain the word clock if Apollo x16 is in the middle of the word clock chain. The correct method to connect Apollo x16 in the middle of a word clock chain is to use a T-connector at Apollo x16's word clock input and leave Apollo x16's word clock output unconnected. In this configuration, the Termination switch should not be engaged.

(19) AES/EBU Ports

The AES/EBU ports provide two channels of digital I/O with resolutions up to 24-bit at 192 kHz via XLR connectors. For optimum results, use only high-quality 110-ohm XLR cables specifically designed for AES/EBU digital audio.

SR Convert

Sample rate conversion can be enabled on the AES/EBU input. This function is set in the AES/EBU input channel strip within the UAD Console application. When sample rate conversion is enabled and the sample rate of the incoming AES/EBU signal does not match the sample rate specified in the UAD Console application, the AES/EBU signal is converted to match Apollo x16's sample rate.

Note: When Apollo x16 is set to use AES/EBU as the master clock source, sample rate conversion is inactive.

Mirror Monitor Outputs

The AES/EBU output can be configured to mirror the Monitor outputs, for routing the stereo Monitor signal to the stereo AES/EBU input of other devices. This feature is set with the DIGITAL MIRROR menu in the Hardware panel within the UAD Console Settings window.

Analog I/O

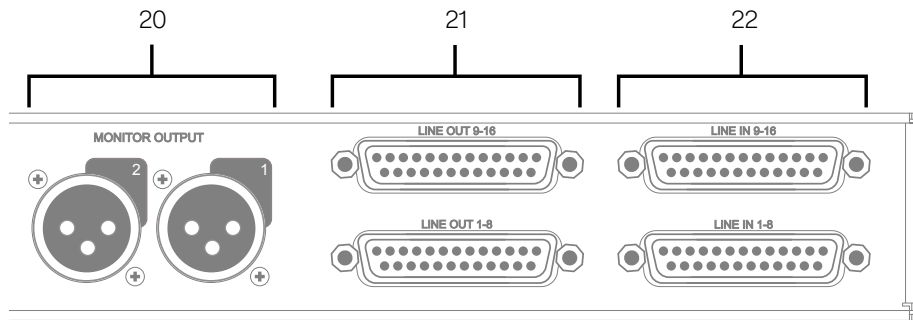

Apollo x16 rear panel (analog portion)

(20) Left & Right Monitor Outputs

These balanced XLR jacks are line-level analog outputs typically used for connection to a stereo loudspeaker monitoring system. The signal levels at these outputs are controlled with the Monitor Level & Mute knob (#12). The Monitor Outputs are DC coupled.

The Monitor Outputs can be configured to use an operating level of +4 dBu (default value) or -10 dBV. This option is set in the Hardware panel within the UAD Console Settings window. For details, refer to the [UAD Console Manual](#).

The Monitor Outputs are completely independent from the 16 line outputs (except when ALT monitoring is configured). By default, these outputs are labeled MON L and MON R in Apollo's device drivers. In the DAW, the "1-2" or "L-R" or "Main" outputs are routed to these outputs (these labels vary within each particular DAW).

Tip: The AES/EBU output (#19) can be configured to mirror the Monitor Outputs, for routing the stereo monitor signal to the stereo AES/EBU input of other devices. This feature is set with the DIGITAL MIRROR menu in the Hardware panel within the UAD Console Settings window.

(21) Line Outputs 1 – 16

The 16 analog outputs are accessed via dual female DB25 connectors. Each DB25 jack carries eight balanced line-level channel outputs using standardized Tascam wiring. The Line Outputs are DC coupled.

Note: See [DB25 Wiring](#) for connector pinouts.

Line Output Headroom

By default, the operating level of the line outputs is +20 dBu. The line outputs and inputs can be globally configured to operate at +24 dBu signal levels with the HEADROOM menu in the Settings>Hardware panel within the UAD Console application.

+24 dBu operation is typically used for interfacing with professional audio equipment such as large format consoles, analog tape machines, and similar devices that require higher signal levels. For additional details about +24 dBu operation, see the Apollo Thunderbolt Software Manual.

Line Output Reference Levels

The Line Outputs can be configured in adjacent pairs to use either -10 dBV or $+4$ dBu reference levels. This function is configured in the Hardware panel within the UAD Console Settings window. Refer to the [UAD Console Manual](#) for details.

ALT Outputs 1 – 4

Apollo x16 features ALT (alternate) monitoring capabilities. ALT monitoring can be used to control up to two alternate pairs of monitor speakers.

When ALT monitoring is enabled, the output level and muting of line outputs 1 & 2 (ALT 1) and 3 & 4 (ALT 2) are controlled by the Monitor Level & Mute knob (#12). ALT monitoring is enabled in the Hardware panel within the UAD Console Settings window by increasing the ALT COUNT setting to a non-zero value.

(22) Line Inputs 1 – 16

The 16 analog inputs are accessed via dual female DB25 connectors. Each DB25 jack carries eight balanced line-level channel inputs using standardized Tascam pinouts.

Note: See [DB25 Wiring](#) for connector pinouts.

Line Input Headroom

By default, the operating level of the line inputs is $+20$ dBu. The line inputs and outputs can be globally configured to operate at $+24$ dBu signal levels with the HEADROOM menu in the Settings>Hardware panel within the UAD Console application.

$+24$ dBu operation is typically used for interfacing with professional audio equipment such as large format consoles, analog tape machines, and similar devices that require higher signal levels. For additional details about $+24$ dBu operation, see the Apollo Thunderbolt Software Manual.

Line Input Reference Levels

The Line Inputs can be individually configured to use -10 dBV or $+4$ dBu reference levels. This option is set in the channel input strips within the UAD Console application. Refer to the [UAD Console Manual](#) for details.

Interconnections

Installation Notes

- Apollo may get hot during normal operation if it doesn't receive adequate airflow circulation around its chassis vents. For optimum results when mounting Apollo in a rack, leaving at least one empty rack space above the unit to allow adequate airflow for cooling is strongly recommended.
- If Apollo is installed near other heat generating equipment, external cooling (such as a fan) may be needed to keep the ambient temperature below 104°F (40°C).
- As with any sound system, the following steps are recommended to avoid audio spikes in your speakers and headphones:
 1. Apply power to the speakers last, after all other devices (including Apollo) are powered on.
 2. Turn off the speakers first, before all other devices (including Apollo) are powered off.
 3. Remove headphones from ears before powering Apollo on or off.

Connection Notes

Thunderbolt

- Apollo must be connected via a Thunderbolt 3 cable (not included) to computers that have Thunderbolt 3 ports.*
- Connect only one Thunderbolt 3 cable between Apollo and the host computer. Thunderbolt is a bidirectional protocol.
- Apollo cannot be bus powered via Thunderbolt. The included external power supply must be used.
- Thunderbolt bus power is supplied to downstream (daisy-chained) peripheral devices. Apollo must be powered on for the daisy-chained peripheral to receive Thunderbolt bus power.

**Mac Only: With Mac computers only, Apollo can be connected to Thunderbolt 1 and Thunderbolt 2 computer ports via the Apple Thunderbolt 3 to Thunderbolt 2 adapter. Visit help.uaudio.com for details.*

Apollo Expanded

- When more I/O and/or DSP is needed, up to four Apollo interfaces and six UAD devices total can be cascaded together via Thunderbolt in a multiple-unit configuration. For complete details about multi-unit cascading, refer to the [UAD Console Manual](#).

About Thunderbolt 3 Ports and Cables

Important: Although Thunderbolt 3 always uses USB-C connectors, not all USB-C ports are Thunderbolt 3 ports. Similarly, not all USB-C cables are Thunderbolt 3 cables. Always connect Apollo to a Thunderbolt 3 port with a Thunderbolt 3 cable.

USB-C is not Thunderbolt 3

Thunderbolt 3 uses USB-C connections to transfer data and power. However, USB-C is simply a connector type; it doesn't determine the type of data used by the connector. For example, USB-C connections can be used for Thunderbolt 3, USB 3.1, and other data protocols, so USB-C connections are not always interchangeable.

Does your USB-C connector support Thunderbolt 3?



To determine if a USB-C port or cable connector supports Thunderbolt 3, look for the Thunderbolt icon. The Thunderbolt icon on a USB-C port or cable means the connector supports Thunderbolt 3. Alternately, confirm Thunderbolt 3 compatibility with the device and/or cable manufacturer.



Thunderbolt icon on USB-C cable (left) and USB-C port (right)

Typical Setup

The diagram below illustrates an Apollo x16 setup example that could be used for recording an ensemble. ALT monitors are connected for comparing different speakers.

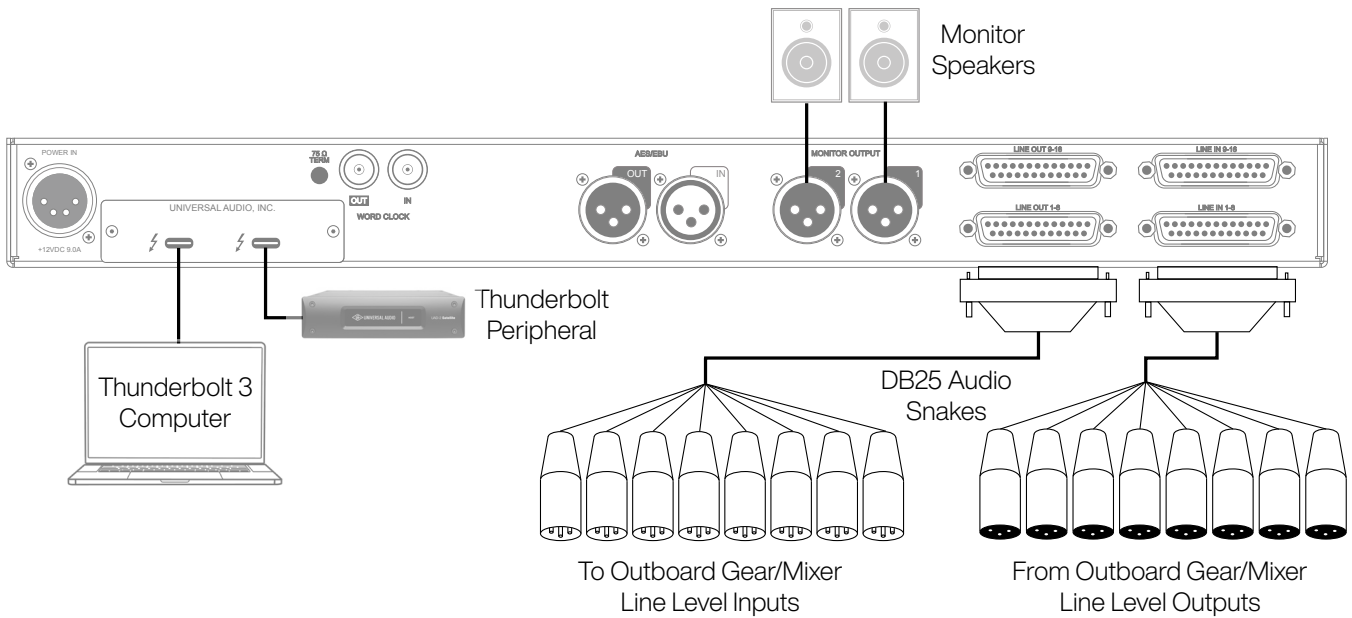

Typical Apollo x16 connections

Apollo Expanded: Multi-Unit Wiring

The diagram below illustrates an example of how to interconnect multiple Apollo units and the host computer via Thunderbolt 3.

Important: For complete details about system operation when multi-unit cascading, see the [UAD Console Manual](#).

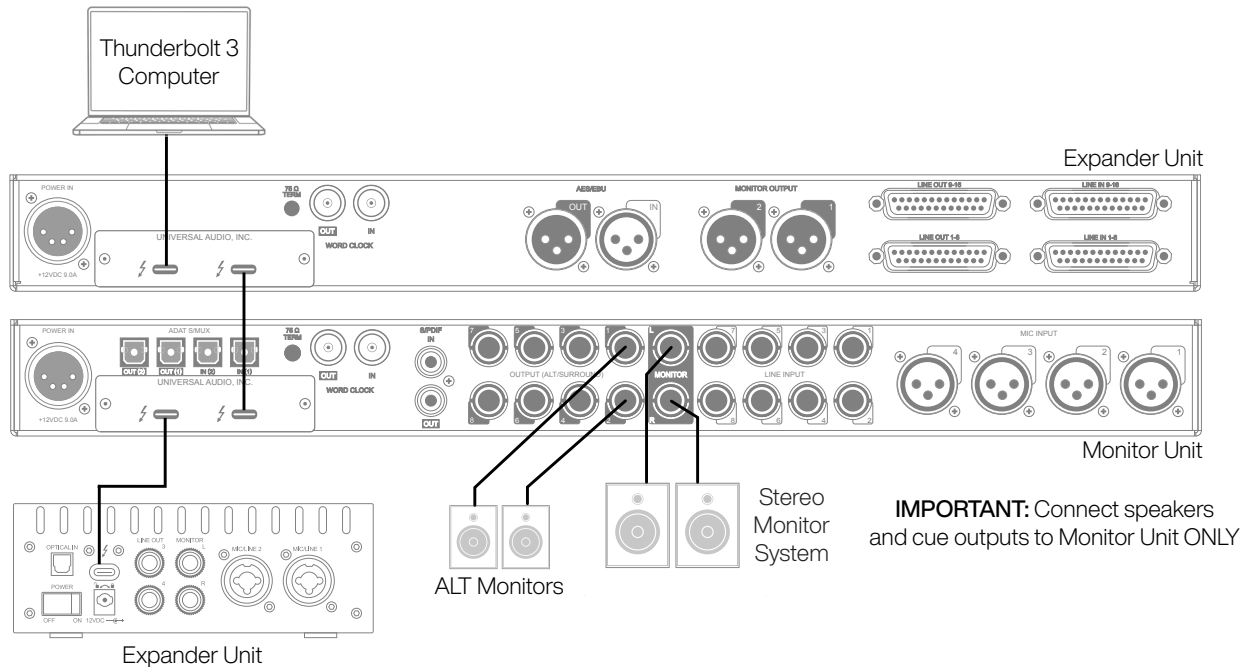

Connecting multiple Apollo units via Thunderbolt 3

Apollo Expanded Wiring Notes

- Apollo device ordering and Thunderbolt ports used (second port on Apollo vs. second port on computer, placement within daisy chain, etc) is not important.
- In this example diagram, Apollo x8 is the monitor (master) unit designated in the UAD Console Settings hardware panel and Apollo x16 is the expander unit. Connect speakers (including ALT speakers) and any cue outputs to the monitor unit only.
- Do not interconnect any Word Clock, FireWire, ADAT, or MADI ports between any Apollo units. All Apollo clocking is automatically managed via Thunderbolt.
- Up to four Apollo units and six UAD devices total can be combined within the same system.
- The computer and all Apollo/UAD -2 units must be connected to the same Thunderbolt bus.
- (Mac only) Apollo units with Thunderbolt 3 can be mixed with older Apollo units with Thunderbolt 2 by using compatible Thunderbolt 3 to Thunderbolt 2 adapters.

Software Setup

Note: Items on this overview page are detailed in the Apollo Software Manual. See [About Apollo Documentation](#) for related information.

System Requirements

All system requirements must be met for Apollo to operate properly. Before proceeding with installation, view the [Apollo X system requirements](#).

Software Installation

The UAD software must be installed to use the hardware and UAD-2 plug-ins. The UAD software installer contains the Apollo software, drivers, and UAD-2 plug-ins.

UA Connect Application

You'll use UA Connect, our software management program, to obtain and install the UAD software and UAD Console. To get UA Connect, visit:

uaudio.com/downloads/uad

Note: For optimum results, connect and power on Apollo before installing the software.

Latest Software

To obtain the latest UAD software after initial registration, use the UA Connect application.

System Configuration

Details about setting up the Apollo system, including how to integrate with a DAW and related information, are included in the Apollo Software Manual.

UAD Console

The UAD Console application is the software interface for the Apollo hardware. UAD Console controls Apollo and its digital mixing, monitoring, Unison technology, and Realtime UAD Processing features. UAD Console is also used to configure Apollo settings such as sample rate, clock source, reference levels, and more.

For complete details, view the [UAD Console Manual](#).

How to get UAD Console

1. In UA Connect, click the Apollo & UAD-2 tab.
2. Click the Download button next to UAD Console. If UAD Console is already installed, you can click the Update button (if an update is available).
3. After the software is downloaded, click Install to complete the installation.

UA Support Videos

Informational videos are available to help you get started with Apollo at help.uaudio.com.

Specifications

All specifications are typical performance unless otherwise noted. Tested with the Audio Precision APx555 Audio Analyzer under the following conditions: 48 kHz internal sample rate, 24-bit sample depth, 20 kHz measurement bandwidth, +24 dBu headroom, balanced output, and internal clock.

Specifications are subject to change without notice.

SYSTEM	
<i>I/O Complement</i>	
Simultaneous Channel I/O Count (analog + digital)	18 x 20
Analog Line Inputs	16
Analog Line Outputs (DC coupled)	16
Analog Monitor Outputs (DC coupled)	Two (one stereo pair)
Digital Audio Ports (AES/EBU)	One input, one output
Thunderbolt 3 Ports*	Two
Word Clock	One input, one output
<i>*(Mac only) Thunderbolt 1 and 2 connections supported via Apple Thunderbolt 3 to Thunderbolt 2 adapter</i>	
<i>A/D - D/A Conversion</i>	
Simultaneous A/D conversion	16 channels
Simultaneous D/A conversion	18 channels
Supported Sample Rates (kHz)	44.1, 48, 88.2, 96, 176.4, 192
Bit Depth Per Sample	24
Analog Round-Trip Latency	1.1 milliseconds @ 96 kHz sample rate
Analog Round-Trip Latency through four UAD legacy plug-ins (included) via UAD Console software	1.1 milliseconds @ 96 kHz sample rate (no additional latency via Realtime UAD Processing)

ANALOG I/O	
<i>Line Inputs 1 – 16</i>	
Frequency Response	20 Hz – 20 kHz, ±0.04 dB
Dynamic Range	124 dB (A-weighted)
THD + Noise (1 kHz @ 23 dBu, -1 dBFS)	-115 dB (0.00018%)
Maximum Input Level (reference level @ +4 dBu)	24 dBu
Input Impedance	10 K Ω
Connector Type	Two female DB25, Tascam wiring
<i>Line Outputs 1 – 16</i>	
Frequency Response	20 Hz – 20 kHz, ±0.02 dB
Dynamic Range	127 dB (A-weighted)
THD + Noise (1 kHz @ 23 dBu, -1 dBFS)	-123 dB (0.000068%)
Maximum Output Level	
Reference level @ +4 dBu	24 dBu
Reference level @ -10 dBV	12.2 dBu
Output Impedance	100 Ω
Connector Type	Two female DB25, Tascam wiring
<i>Monitor Outputs 1 – 2</i>	
Frequency Response	20 Hz – 20 kHz, ±0.02 dB
Dynamic Range	133 dB (A-weighted)
Total Harmonic Distortion + Noise Ratio (1 kHz @ -1 dBFS)	-129 dB (0.000037%)
Maximum Output Level	
Reference level @ +4 dBu	24 dBu
Reference level @ -10 dBV	10 dBV (12.2 dBu)
Output Impedance	100 Ω
Connector Type	Balanced male XLR (pin 2 hot)
DIGITAL I/O	
<i>AES/EBU</i>	
Digital Audio Ports	One input, one output
AES/EBU Channels	One stereo input, one stereo output
Supported Sample Rates (kHz)	44.1, 48, 88.2, 96, 176.4, 192
Connector Type	XLR
Format	IEC 60958 Type I
<i>Word Clock</i>	
Connector Type	BNC
Lock Range	±4% of any supported sample rate
Word Clock Input Termination	75 Ω , switchable
<i>Synchronization Sources</i>	
Internal, Word Clock, AES/EBU	

ELECTRICAL	
Power Supply	External AC-to-DC power supply, level VI compliant
AC Input Connector Type	IEC male
AC Requirements	100V – 240V AC, 47 – 63 Hz, 1.6 A max
DC Connector Type	XLR 4-pin locking male (Neutrik P/N NC4MDM3-H)
DC Requirements	12 VDC, 6 A
Maximum Power Consumption	72 Watts (30 W typical)
ENVIRONMENTAL	
Ambient Temperature Range	32° to 104° F (0° to 40° C)
MECHANICAL	
<i>Dimensions</i>	
Width	19" (482.6 mm)
Height (1U rack space)	1.74" (44.2 mm)
Depth, Chassis Only	12" (305 mm)
Depth, Including Knob & Jack Protrusions	13.5" (343.1 mm)
Shipping Box (Width x Depth x Height)	23.62" x 16.73" x 7.68" (600 mm x 425 mm x 195 mm)
<i>Weight</i>	
Shipping Weight (with box & accessories)	16.76 lbs (7.6 kg)
Weight (bare unit)	8.5 lbs (3.88 kg)
<i>Package Contents</i>	
Apollo x16 Audio Interface	
External Power Supply	
AC Power Cable (IEC)	Region specific (USA, EU, UK, ANZ, or Japan)
Set of (4) Rack-Mount Screws	
Getting Started URL Card	

Block Diagram

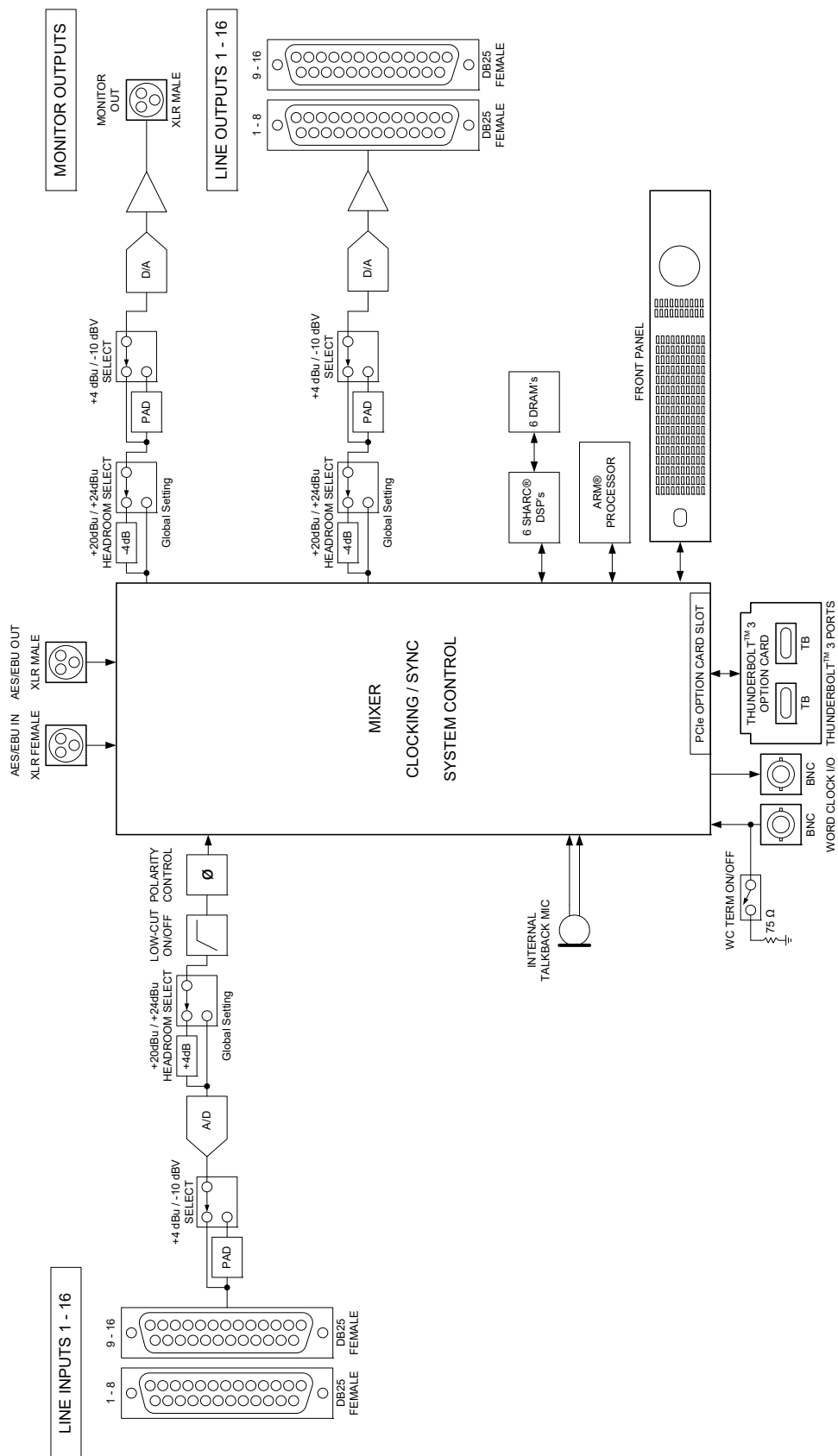

Apollo x16 Gen 2 Hardware Block Diagram

DB25 Wiring

Apollo x16's line inputs and outputs are accessed via 25-pin D-sub female connectors. Each DB25 jack carries eight balanced line-level audio channels on the standardized Tascam pinouts also used with Digidesign and Avid products.

DB25 Connector Pin Numbers

The pin numbers for female DB25 connectors are shown in the diagram below. When facing the Apollo x16 rear panel, pin 1 is the upper rightmost pin.

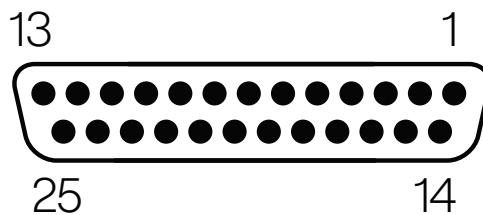

Apollo x16 female DB25 pin numbers

DB25 Connector Wiring

The signals carried on the female DB25 connector pins are listed in the table below. Pinouts are identical for inputs and outputs.

Apollo x16 DB25 Connector Pinouts								
Pin	Channel	Signal	Pin	Channel	Signal	Pin	Channel	Signal
1	8	Hot	9	3	Cold	17	6	Cold
2	8	Ground	10	2	Hot	18	5	Hot
3	7	Cold	11	2	Ground	19	5	Ground
4	6	Hot	12	1	Cold	20	4	Cold
5	6	Ground	13	-	No Connect	21	3	Hot
6	5	Cold	14	8	Cold	22	3	Ground
7	4	Hot	15	7	Hot	23	2	Cold
8	4	Ground	16	7	Ground	24	1	Hot
						25	1	Ground

Troubleshooting

If your Apollo rack unit isn't behaving as expected, check these common troubleshooting items. If you still experience issues after performing these checks, contact [Technical Support](#).

SYMPTOM	ITEMS TO CHECK
Unit won't power on	<ul style="list-style-type: none"> Confirm power supply connections at power supply input and back of unit Confirm Power switch is in UP position Confirm AC power is available at wall socket by plugging in a different device
No monitor output	<ul style="list-style-type: none"> Confirm connections, power, and volume of monitoring system Confirm monitor knob is turned up Confirm monitor outputs are not muted (push monitor knob) Confirm monitor LEDs are active (check signal flows)
Can't hear preamp channels	<ul style="list-style-type: none"> Confirm preamp gain is turned up for the channel(s) Confirm MUTE is not engaged in UAD Console input channel strip
Can't hear mic or line input(s)	<ul style="list-style-type: none"> Confirm mic/line switch setting is correct for the channel Confirm nothing is plugged into the channel's Hi-Z input Confirm MUTE is not engaged in UAD Console input channel strip
Can't hear Hi-Z input(s)	<ul style="list-style-type: none"> Confirm volume on connected device is turned up Confirm Hi-Z input cable is 1/4" TS only (not TRS) Confirm MUTE is not engaged in UAD Console input channel strip
Can't hear mic input(s)	<ul style="list-style-type: none"> Confirm +48V phantom power is enabled (if required by microphone)
Preamp controls have no effect on channel	<ul style="list-style-type: none"> Confirm desired channel is selected for control (push PREAMP knob to select) Preamp controls are not available for non-preamp channels
Can only adjust preamp input channels	<ul style="list-style-type: none"> Signal levels for all non-preamp inputs, including digital inputs, are adjusted at the device connected to those inputs
Audio glitches and/or dropouts during playback	<ul style="list-style-type: none"> Increase audio buffer size setting Confirm clocking setups; check cable connections and confirm all device clocks are synchronized to one master clock device
Undesirable echo/phasing	<ul style="list-style-type: none"> Confirm only one input monitoring system is enabled (UAD Console or DAW – not both)
HOST indicator is unlit or red	<ul style="list-style-type: none"> Confirm Thunderbolt 3 connections Confirm Apollo software is installed Power Apollo off then on, and restart computer Reinstall Apollo software Try a different Thunderbolt 3 cable
Static and/or white noise is heard when nothing is plugged in	<ul style="list-style-type: none"> Mute or lower preamp gain to minimum on all unused preamp channels (mic preamps can emit noise even when nothing is plugged in) Some UAD plug-ins model the noise characteristics of the original equipment. Defeat the noise model in the UAD plug-in GUI, or mute the channel containing the plug-in to temporarily mute the noise
Various LEDs inside the unit are blinking	<ul style="list-style-type: none"> This is normal operational behavior that can be safely ignored
Apollo rack is behaving unexpectedly	<ul style="list-style-type: none"> As a last resort, perform a hardware reset on the unit by following these steps: <ol style="list-style-type: none"> Power off Apollo Press and hold the PREAMP, LOW CUT, and POLARITY controls Power on Apollo X while continuing to hold all three controls After all front panel LEDs flash rapidly (after several seconds), release the controls.

Notices



Important Safety Information

1. Read these safety instructions and the instruction manual of the product.
2. Keep these safety instructions and the instruction manual of the product. Always include all instructions when providing the product to other parties.
3. Heed all warnings.
4. Follow all instructions.
5. Do not use this apparatus near water.
6. Only clean the product when it is not connected to the power supply system. Clean only with a dry cloth.
7. Do not block any ventilation openings. Install in accordance with the manufacturer's instructions.
8. Do not install near any heat sources such as radiators, heat registers, stoves, or other apparatus (including amplifiers) that produce heat.
9. Only operate the product from the type of power source indicated on the power supply unit.
10. Protect the power cord from being walked on or pinched, particularly at plugs, convenience receptacles, and the point where it enters into and/or exits from the apparatus.
11. Only use attachments/accessories specified by the manufacturer.
12. Unplug this apparatus during lightning storms or when unused for long periods of time.
13. Refer all servicing to qualified service personnel. Servicing is required when the apparatus has been damaged in any way, such as when the power supply cord or plug is damaged, liquid has been spilled into or objects have fallen into the apparatus, or when the apparatus has been exposed to rain or moisture, does not operate normally, or has been dropped.
14. **Warning:** To reduce the risk of fire or electric shock, do not expose this apparatus to rain or moisture. Objects filled with liquids, such as vases, should not be placed on this apparatus.
15. To completely disconnect this apparatus from the AC mains, disconnect the power supply cord plug from the AC receptacle.
16. The mains plug of the power supply cord shall remain readily accessible.
17. Do not attempt to open the product housing. The warranty is voided for products opened by the customer.
18. Let the product reach ambient temperature before switching it on.
19. **Caution:** High signal levels can damage your hearing and your loudspeakers. Reduce the volume on the connected audio devices before switching on the product; this will also help prevent acoustic feedback.
20. Intended use. The product is designed for indoor use. The product can be used for commercial purposes. It is considered improper use when the product is used for any application not named in the corresponding instruction manual. Universal Audio does not accept liability for damage arising from improper use or misuse of this product and its attachments/ accessories. Before putting the product into operation, please observe the respective country-specific regulations.

Manufacturer's Declarations

Warranty

The product is covered by a limited warranty. For the current terms of such warranty, please visit uaudio.com/eula.

Maintenance



CAUTION: To reduce the risk of electric shock, do not open the unit.

This product does not contain a fuse or any other user-replaceable parts. The unit is internally calibrated at the factory. No internal user adjustments are available.

Repair Service

If you are having trouble with your hardware, first check all system setups, connections, and operating instructions. If that doesn't help, contact our Customer Care team.

To learn about repair service, or for Customer Care, visit help.uaudio.com.

Notes on Disposal

In compliance with the following requirements:

WEE-DIRECTIVE (2012/19/EU)



The symbol of the crossed-out wheeled bin on the product, the battery/rechargeable battery (if applicable), and/or the packaging indicates that these products must not be disposed of with normal household waste, but must be disposed of separately at the end of their operational lifetime. For packaging disposal, please observe the legal regulations on waste segregation applicable in your country.

Further information on the recycling of these products can be obtained from your municipal administration or from the municipal collection points. The separate collection of waste electrical and electronic equipment, batteries/rechargeable batteries (if applicable) and packaging, is used to promote the reuse and recycling and to prevent negative effects caused by e.g., potentially hazardous substances contained in these products. Herewith, you can make an important contribution to the protection of the environment and public health.

EU Declaration of Conformity



- RoHS-Directive (2015/863/EU)
- Low Voltage Directive (2014/35/EU)
- EMC Directive (2014/30/EU)
- REACH Directive (EC1907/2006)

Class A Device Statements

United States

Note: This equipment has been tested and found to comply with the limits for a Class A digital device pursuant to Part 15 of the FCC Rules. These limits are designed to provide reasonable protection against harmful interference when the equipment is operated in a commercial environment. This equipment generates, uses, and can radiate radio frequency energy and, if not installed and used in accordance with the instruction manual, may cause harmful interference to radio communications. Operation of this equipment in a residential area is likely to cause harmful interference to radio communications. Operation of this equipment in a residential area is likely to cause harmful interference in which case the user will be required to correct the interference at their own expense.

Any modifications to the unit, unless expressly approved by Universal Audio, could void the User's authority to operate the equipment.

South Korea

이 기기는 업무용(A급) 전자파 적합기기로서 판매자 또는 사용자는 이 점을 주의하시기 바라며, 가정외의 지역에서 사용하는 것을 목적으로 합니다.

(Translation: This device obtained EMC registration for office use (Class A), and may be used in places other than home. Sellers and/or users need to take note of this.)

Product Label



Compliance

This product complied with the following requirements:

- Subpart B of Part 15 of FCC Rules for Class A digital devices (ANSI C63.4 methods)
- Innovation, Science and Economic Development Canada Interference Causing Equipment Standard ICES-003, “Information Technology Equipment (ITE - Limits and methods of measurement,” Issue 7, dated October 2020 (Class A) (ANSI C63.4 methods)
- VCCI-CISPR 32:2016 “Technical Requirements” for multimedia equipment (Class A)
- AS/NZS CISPR 32:2015 +A1 +A11 2020 “Electromagnetic compatibility of multimedia equipment - Emission requirements” (Class A)
- CISPR 32:2015 +A1:2019, “Electromagnetic compatibility of multimedia equipment - Emissions requirements” (Class A)
- EN 55032:2015 +A11 +A1:2020, “Electromagnetic compatibility of multimedia equipment - Emissions requirements” (Class A)
- BS EN 55032:2015 +A11 +A1:2020, “Electromagnetic compatibility of multimedia equipment - Emissions requirements” (Class A)
- CISPR 35:2016 “Electromagnetic compatibility of multimedia equipment - Immunity requirements”
- EN 55035:2017 + A11:2020 “Electromagnetic compatibility of multimedia equipment - Immunity requirements”
- BS EN 55035:2017 + A11:2020 “Electromagnetic compatibility of multimedia equipment - Immunity requirements”
- QCVN 118:2018/BTT “National technical regulation on Electromagnetic compatibility of multimedia equipment - Emission requirements” (Class A)
- KS C 9832, KS C 9835 (Class A)

South Korea Compliance Certification

- Applicant Name: Universal Audio, Inc.
- Equipment Name: Apollo x16 Gen 2
- Model Name: Apollo x16 Gen 2
- Registration Number: R-R-UAO-APOLLOX16G2
- Manufacturer/Country of Origin: Universal Audio, Inc. / Malaysia, China, Vietnam
- Date of Registration: 2024-08-21

End User License Agreement

Your rights to the Software are governed by the accompanying End User License Agreement, a copy of which can be found at: www.uaudio.com/eula

Copyrights & Trademarks

Copyright ©2024 Universal Audio, Inc. All rights reserved.

UA owns certain trademarks (or applications therefor) that are used in connection with the following UA Software Products and/or the UAD Platform (together “UA Marks”), including, without limitation:

1176, 1176 LN, 175-B, 176, APOLLO, APOLLO TWIN, ARROW, ASTRA MODULATION MACHINE, BOCK, BOCK AUDIO and BOCK AUDIO logo, CENTURY TUBE CHANNEL STRIP, CYCLOSONIC PANNER, DEL-VERB, DREAMVERB, DYTRONICS, EQP-1A, GOLDEN REVERBERATOR, GOLDEN REVERBERATOR & UA Diamond Design, GOLDEN REVERBERATOR & UA Diamond Design (Series), HELIOS, LA-2A, LA-3A, LUNA, OPAL, OX, OX AMP TOP BOX & Design, OXIDE, POWERED PLUG-INS, RAYMOND, SHAPE, SOUNDELUX and SOUNDELUX USA logo, SPHERE, SPHERE UNIVERSAL AUDIO and UA Diamond Design, STANDARD and UA Diamond Design, STARLIGHT ECHO STATION, TELETRONIX, THE AUTHENTIC SOUND OF ANALOG, TOWNSEND LABS, TRI-STEREO CHORUS, U UNISON PREAMPS & Design, UA Diamond Design, UAD, UAD 2 POWERED PLUG-INS, UAD SPARK, UAD-2 LIVE RACK, UAFX (Stylized), UNIVERSAL AUDIO, UNIVERSAL AUDIO and UA Diamond Design, VOLT UNIVERSAL AUDIO and UA INC. Diamond Design, APOLLO | X, DREAM 65, POLYMAX, RUBY 63, SETTING THE TONE SINCE 1958, SOUNDELUX USA, SPHERE UNIVERSAL AUDIO and UA Diamond Design, UNIVERSAL AUDIO APOLLO, UNIVERSAL AUDIO UAD, VOLT UNIVERSAL AUDIO and UA Diamond Design, WATERFALL B3, WOODROW 55.

Unless otherwise agreed to in writing under a separate agreement, Customer shall have no interest in any UA Mark and UA will remain the sole and exclusive owner of all right, title and interest in all UA Marks and all applications, reissues, divisions, re-examinations, renewals or extensions thereof. Other company and product names mentioned herein are trademarks of their respective owners.

ASIO is a trademark and software of Steinberg Media Technologies GmbH.

This manual and any associated software, artwork, product designs, and design concepts are subject to copyright protection. No part of this document may be reproduced, in any form, without prior written permission of Universal Audio, Inc.

Disclaimer

The information contained in this manual is subject to change without notice. Universal Audio, Inc. makes no warranties of any kind with regard to this manual, including, but not limited to, the implied warranties of merchantability and fitness for a particular purpose. Universal Audio, Inc. shall not be liable for errors contained herein or direct, indirect, special, incidental, or consequential damages in connection with the furnishing, performance, or use of this material.

Technical Support

Universal Audio Knowledge Base

The UA Knowledge Base is your complete technical resource for configuring, operating, troubleshooting, and repairing UA products.

You can watch helpful support videos, search the Knowledge Base for answers, get updated technical information that may not be available elsewhere, and more.

[UA Knowledge Base](#)

Universal Audio YouTube Channel

The Universal Audio YouTube Channel at youtube.com includes helpful support videos for setting up and using UA products.

[UA YouTube Channel](#)

Universal Audio Community Forums

The unofficial UA discussion forums are a valuable resource for all Universal Audio product users. This website is independently owned and operated.

www.uadforum.com

Customer Care

To contact UA support staff for technical or repair assistance, please visit:

help.uaudio.com

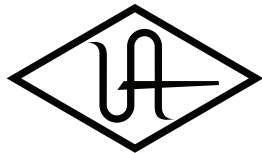

UNIVERSAL AUDIO